

Gail

Ceramics International

Swimming Pool Program

Architectural ceramics of highest quality

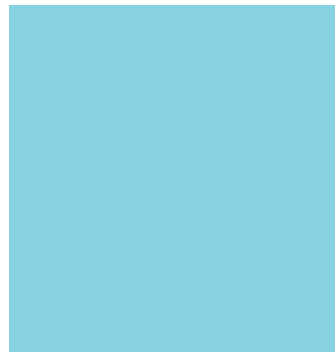

■ Contents

Swimming pool ceramics from GAIL - sustainable by tradition	03
---	----

Robust Ceramics

Collection TERRA	05
Collection NATURA	11
Collection MONTANA	15
Collection COLOSSEO OUTDOOR	19
Collection CUMULUS	21
Collection CONCRET	23

Colourful Ceramics

Collection COMBI-COLOR I	25
Collection COMBI-COLOR II	33
Collection GRIP-STAR SOFT SP I	39
Collection GRIP-STAR SOFT SP II	43
Collection MOSAIC	47
Collection PREMIER I	51
Collection PREMIER II	55

Swimming Pool Ceramics

SPECIAL-FORM	57
------------------------	----

Information

Design and tiling plans	114
Index according to size numbers	116
Index according to colour numbers	118

Please note

Information on safety-related topics (anti-slip properties, etc.) or on our general terms and conditions can be found on our website at www.gail.de

■ Swimming pool ceramics from GAIL – sustainable by tradition

We are delighted to provide you with our catalogue for our swimming pool ceramics and cordially invite you to find out more about our products and solutions.

Our swimming pool ceramics combine long-lasting aesthetics with high resistance and unique product properties that artfully design and protect the walls, floors and facades of your swimming pool project. Our products also offer maximum functionality and give every planner unlimited possibilities to realise their design ideas.

Sustainable natural raw materials are a matter of course for the production of our high-quality tiles and guarantee a resource and environmentally friendly process, from the procurement of raw materials and production through to the utilisation and use of recyclable packaging and other materials.

In short: We make an important contribution to the sustainable architecture of your swimming pool project!

Architects, planners, builders, trade partners and general contractors around the world rely on the quality of our products to realise swimming pool projects that meet the highest standards. If required, we can work with you to develop customised system solutions for - virtually - any swimming pool project. Our technical service will accompany you throughout the process.

We are proud that Gail's robust architectural ceramics are appreciated worldwide and are successfully used in prestigious reference projects around the globe. We are happy to use our expertise and our products to help create successful swimming pool projects that inspire builders, planners and users.

Your GAIL sales team.

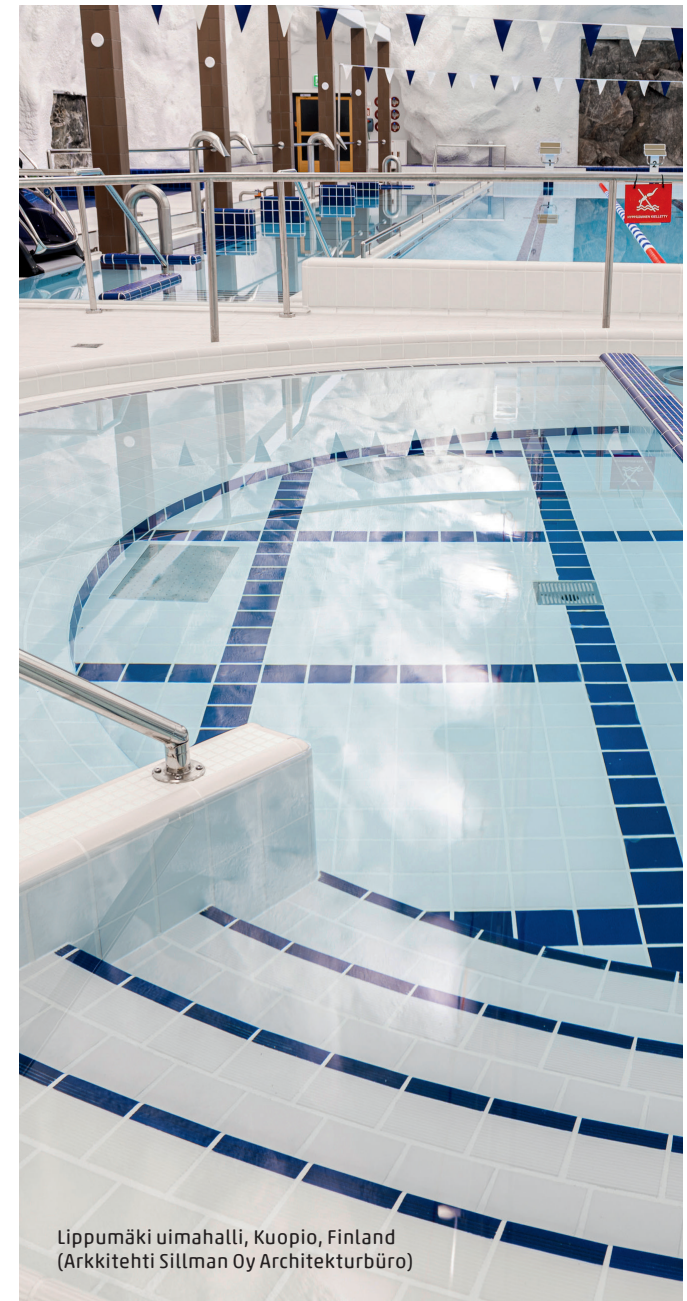

Lippumäki uimahalli, Kuopio, Finland
(Arkkitehti Sillman Oy Arkkitehturbüro)



Buchholzer Höfe, Buchholz/Harburg, Lower Saxony, Germany

Collection **TERRA**

Unglazed full-coloured extruded tiles, strip tiles and accessories

according to DIN EN 14411 AI₃ and AI₆

Examples of appropriate fields of application in indoor and outdoor areas of private, commercial and public swimming pools (especially outdoor pools) and sports facilities:

- pool surrounds
- external staircases
- changing rooms / showers
- entrance areas
- terraces
- saunas
- function rooms
- etc.

Collection TERRA



1000 Grey white B/R 11 U



1125 Tan B/R 11 U



1030 Grey cream B/R 11 U



1300 English red B/R 11 U



1030F Grey cream R 10 U



1705 Light grey B/R 11 U



10307 Grey cream C/R 13 U



1710 Granite B/R 11 U

**Upon request, thickness of 10 - 40 mm is available!
Please contact us for more details.**

Unglazed extruded tiles with textured surface please see collections Grip-Star soft SP I & Grip-Star soft SP II.

Design proposals for stair treads

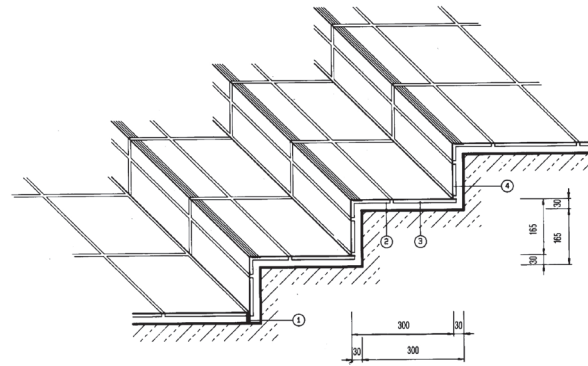

- ① Expansion joint
- ② Angle tile with grooving
- ③ Extruded split tiles
- ④ Extruded split tiles

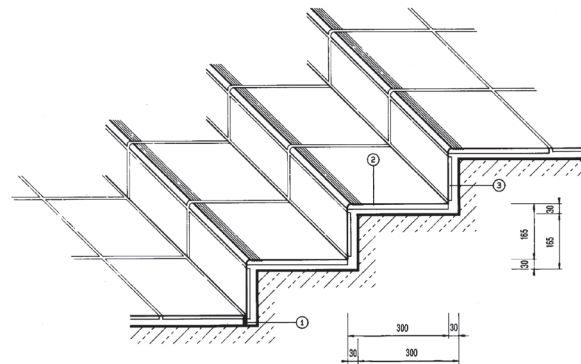

- ① Expansion joint
- ② Stair tile
- ③ Riser tile

All technical details are based on the formula $(2s + a) = 63 \text{ cm}$ ($s = \text{riser}$, $a = \text{tread}$).

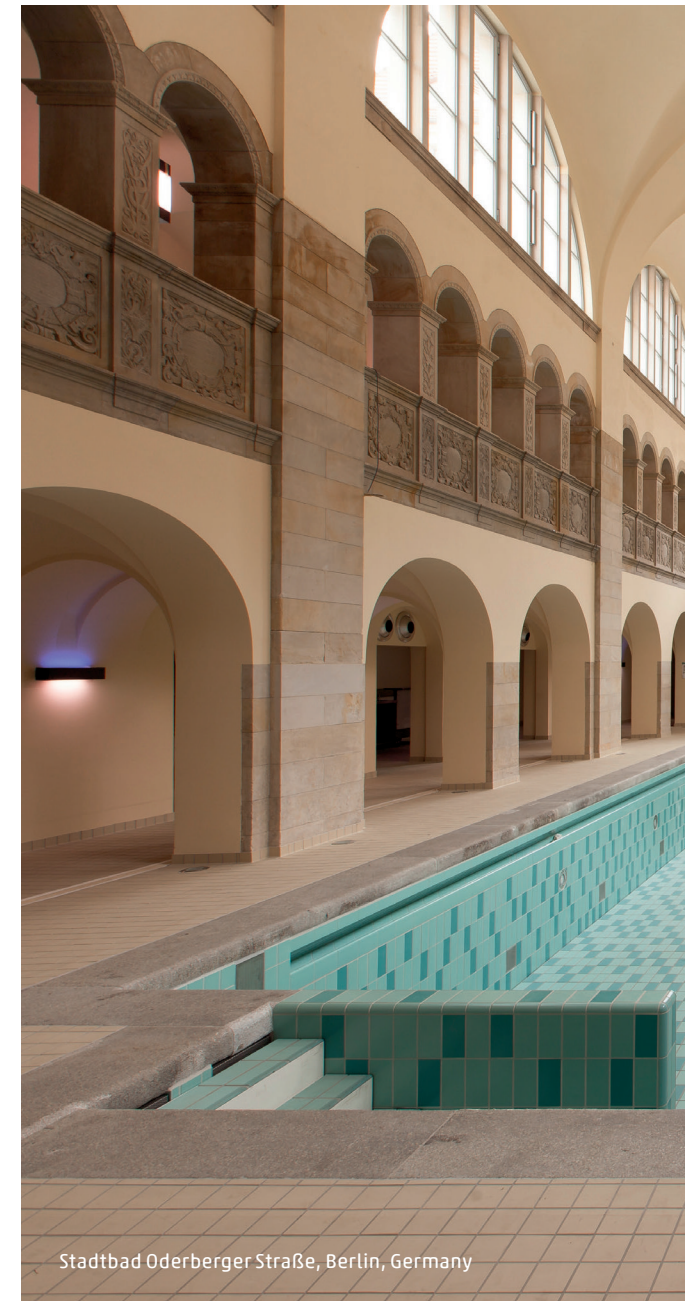

Stadtbad Oderberger Straße, Berlin, Germany

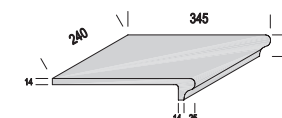
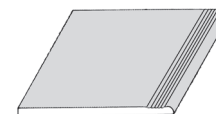
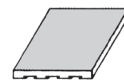
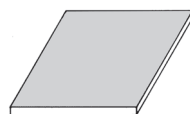
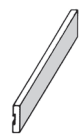

Colour	1100 Extruded split tiles 240 x 115 x 10 mm		2120 4/4 Strip tile 240 x 52 x 10 mm		1610 Extruded split tile 240 x 240 x 12 mm		1200 Extruded split tile 115 x 115 x 10 mm		9068 Stair tile 300 x 240 x 12 mm		4600 Skirting 240 x 78 x 12 mm		9089 Stair tile 345 x 240 x 14/50 mm	
	Price Group/ Piece	Price Group/ m ²	Price Group/ Piece	Price Group/ m ²	Price Group/ Piece	Price Group/ m ²	Price Group/ Piece	Price Group/ m ²	Price Group/ Piece	Price Group/ m ²	Price Group/ Piece	Price Group/ m ²	Price Group/ Piece	Price Group/ m ²
1000		○ 197												
1030 1030F		● 196		● 202				● 203				● 227		
10307		○ 197												
1125		● 197		○ 206						○ 241		○ 222		
1300		● 197		● 206				○ 207		○ 241		● 222		● 247
1710 1705		○ 204		○ 206				○ 207		○ 241		○ 222		
Pieces per m ² /r. m. incl. joints	33		67		16		66		4		4		4	
Approx. weight in KG/1000 pcs	590		280		1587		280		2098		464		3093	
Pieces per bundle	25		50		10		50		8		20		4	
Pieces per pallet	1800		3600		720		3600		336		1920		192	

● = Standard material ○ = Upon request □ = Pallet discount For colours please see p. 6

Collection TERRA

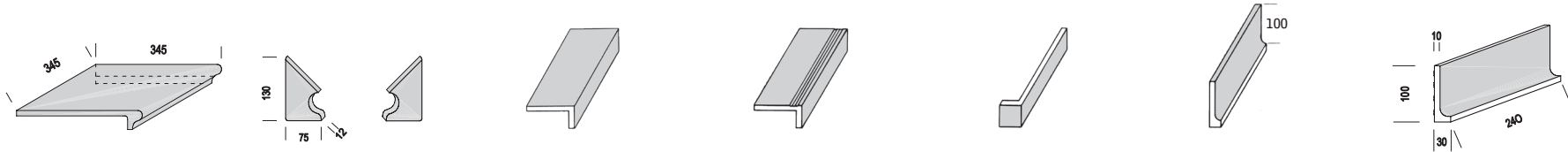

Colour	908903 Corner stair tile 345 x 345 x 14/50 mm		4723/ 4724 Angle skirting, left/right 130 x 75 x 12 mm		4822 Angle tile 240/52 x 115 x 10 mm		4875 Angle tile with safety grooving 240/52 x 115 x 10 mm		2521 1/4 x 4/4 Angle tile 240 x 52/52 x 10 mm		4000 Cove (square top) 240 x 100 x 10/20 mm		4030 Cove (square top) 240 x 100 x 10/30 mm	
	Price Group/ Piece	Price Group/ m ²	Price Group/ Piece	Price Group/ m ²	Price Group/ Piece	Price Group/ m ²	Price Group/ Piece	Price Group/ m ²	Price Group/ Piece	Price Group/ m ²	Price Group/ Piece	Price Group/ m ²	Price Group/ Piece	Price Group/ m ²
1000					○ 232						○ 227			
1030 1030F					● 232			● 235		● 235		● 227		
1125					● 232			○ 235					● 233	
1300	● 276				○ 242 (Piece)			○ 235		● 235			● 233	
1710 1705					○ 232			○ 235					○ 233	
Pieces per m ² /r. m. incl. joints						4		4		16,5		4		4
Approx. weight in KG/1000 pcs		5100				970		970		370		580		710
Pieces per bundle		1				10		8		20		20		16
Pieces per pallet		100				600		568		1200		1920		1248

● = Standard material ○ = Upon request □ = Pallet discount For colours please see p. 6

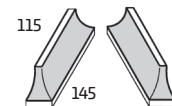
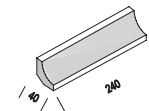
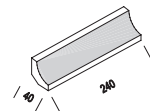
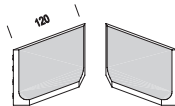
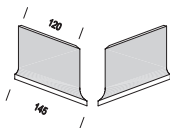
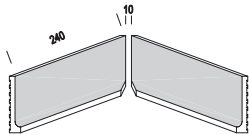
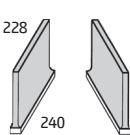

Colour	4001/4002 Cove, external angle, left/right 228/240 x 100 mm		400503/400504 Internal mitre, left/right 240 x 100 x 10/20 mm		4031/4032 Cove, external angle, left/right 125 x 100 x 10/30 mm		403503/403504 Internal mitre, left/right 115 x 100 x 10/30 mm		4100 Cove 240 x 40 x 40 x 7,5 mm		4101 Cove, end piece 240 x 40 x 40 mm		4203/4204 Cove, external angle, left/right 115/145 x 40 x 40 mm	
	Price Group/ Piece	Price Group/ m ²	Price Group/ Piece	Price Group/ m ²	Price Group/ Piece	Price Group/ m ²	Price Group/ Piece	Price Group/ m ²	Price Group/ Piece	Price Group/ m ²	Price Group/ Piece	Price Group/ m ²	Price Group/ Piece	Price Group/ m ²
1030F	● 236 (Piece)		● 236 (Piece)							● 226		● 229		● 236 (Piece)
1125					● 236 (Piece)		● 236 (Piece)							
1300					● 236 (Piece)		● 236 (Piece)							
1710 1705					○ 236 (Piece)		○ 236 (Piece)							
Pieces per m ² /r. m. incl. joints									4					
Approx. weight in KG/1000 pcs		280		530					460		460			280
Pieces per bundle		44		20					48		48			32
Pieces per pallet				1400					2880		2880			

● = Standard material ○ = Upon request □ = Pallet discount For colours please see p. 6

■ Collection TERRA

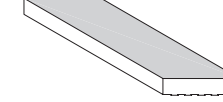
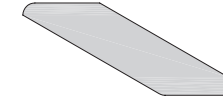
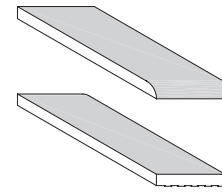
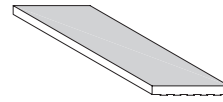
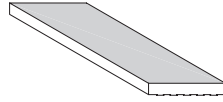
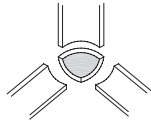

Colour	4102 Cove, internal angle 40 x 40 x 40 mm		1110 Industrial floor tile 240 x 115 x 18 mm		1114 Industrial floor tile 240 x 115 x 14 mm		1115 Rounded on: short side 240 x 115 x 18 mm 1116 Rounded on: long side		1117 Rounded on: left corner 1118 Rounded on: right corner		1120 Industrial floor tile 240 x 115 x 25 mm	
	Price Group/ Piece	Price Group/ m ²	Price Group/ Piece	Price Group/ m ²	Price Group/ Piece	Price Group/ m ²	Price Group/ Piece	Price Group/ m ²	Price Group/ Piece	Price Group/ m ²	Price Group/ Piece	Price Group/ m ²
1000				● 202								● 209
1030 10307				● 202			● 230		● 234			● 208
1030F	● 236 (Piece)			● 202			● 230		● 234			
1125				● 208								
1300				● 208								
1710 1705				○ 208								
2290							● 233		● 240			
Pieces per m ² /r. m. incl. joints			33		33							33
Approx. weight in KG/1000 pcs	50		1130		913		1130		1130			1596
Pieces per bundle	100		12		15		12		12			9
Pieces per pallet			864		1575		864		864			648

● = Standard material ○ = Upon request □ = Pallet discount For colours please see p. 26



Poseidon Gärten, Ischia, Italy

Collection **NATURA**

Unglazed and glazed extruded split tiles, naturally blended colours

according to DIN EN 14411 A1₀

Examples of appropriate fields of application in indoor and outdoor areas of private, commercial and public swimming pools (especially outdoor pools) and sports facilities:

- pool surrounds
- external staircases
- changing rooms / showers
- entrance areas
- terraces
- etc.

■ Collection NATURA

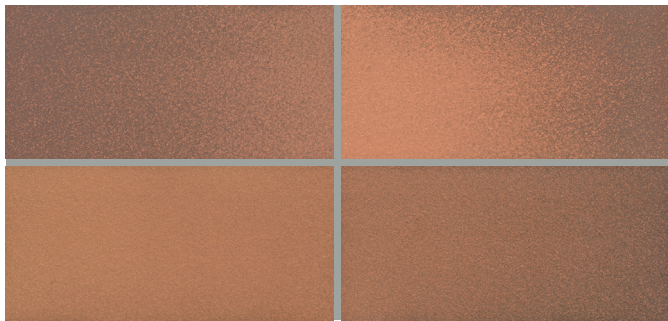

1180 Autumn, unglazed

B/R 12

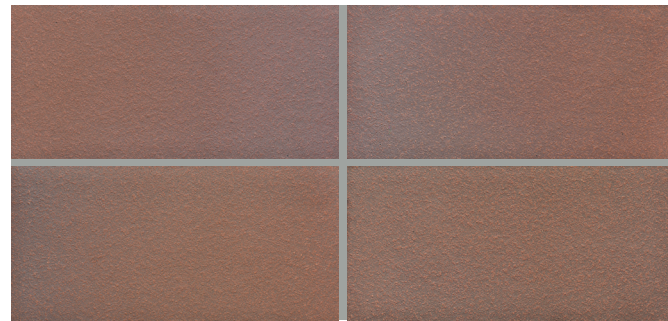

1395 Red flashed, unglazed

B/R 12

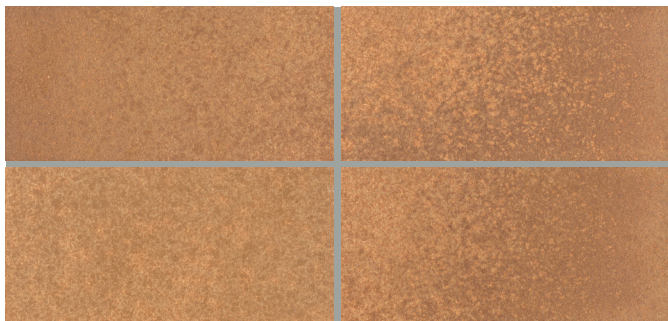

4880 Taunus, glazed

R10

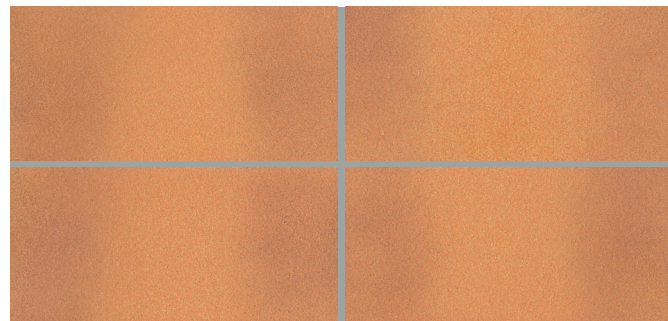

4820 Spessart, glazed

R10

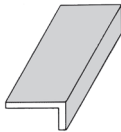
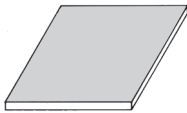
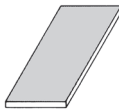

Colour	1100 Extruded split tile 240 x 115 x 10 mm		1610 Extruded split tile 240 x 240 x 11 mm		4822 Angle tile 240/52 x 115 x 10 mm		
	Price Group/ Piece	Price Group/ m ²	Price Group/ Piece	Price Group/ m ²	Price Group/ Piece	Price Group/ m ²	
1180 1395	●	189		●	205	●	234
4820 4880*		○	191			○	234
Pieces per m ² /r. m. incl. joints	33		16		4		
Approx. weight in KG/1000 pcs	600		1386		820		
Pieces per bundle	23		12		8		
Pieces per pallet	2070		864		784		

● = Standard material ○ = Upon request □ = Pallet discount For colours please see p. 12 * Minimum order quantity

Collection NATURA

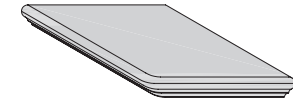
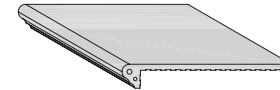
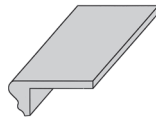

Colour	4888 Decorative angle 240/52 x 115 x 10 mm		4600 Skirting 240 x 73 x 10 mm		9087 Florentine stair tile 340 x 240 x 12 mm		908703 Florentine corner stair tile 340 x 340 x 12 mm	
	Price Group/ Piece	Price Group/ m ²	Price Group/ Piece	Price Group/ m ²	Price Group/ Piece	Price Group/ m ²	Price Group/ Piece	Price Group/ m ²
1180 1395	● 234		● 223		● 253		● 275	
Pieces per m ² /r. m. incl. joints	4		4		4		4800	
Approx. weight in KG/1000 pcs	930		350		3400		1	
Pieces per bundle	8		28		4		1	
Pieces per pallet	648		2520		136			

● = Standard material ○ = Upon request □ = Pallet discount For colours please see p. 12 * Minimum order quantity



Parkbad Hamburg-Volksdorf, Germany (bs2architekten)

Collection **MONTANA**

Glazed extruded tiles with an aesthetic stone appeal

according to DIN EN 14411 AI₆

Examples of appropriate fields of application in indoor and outdoor areas of private, commercial and public swimming pools and sports facilities:

- pool surrounds
- changing rooms / showers
- sauna and wellness areas
- entrance areas
- terraces
- etc.

■ Collection MONTANA



46456 White grey R10 4



46856 Sand beige R10 4

46857 Sand beige B/R11 4



46256 Sand yellow R10 4

46257 Sand yellow B/R11 4

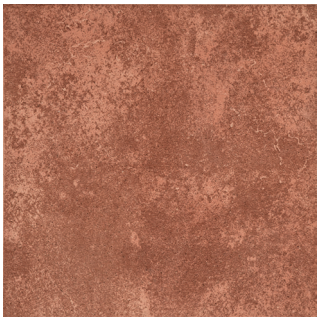

46556 Cotto R10 4

46557 Cotto B/R11 4



46357 Dark brown B/R11 4

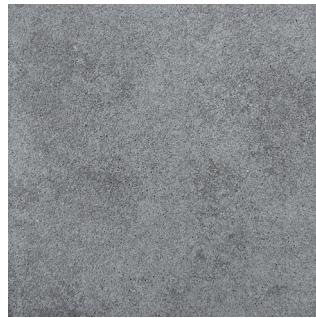

46956 Anthracite R10 4

46957 Anthracite B/R11 4



Parkbad Hamburg-Volksdorf, Germany (bs2architekten)

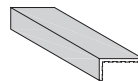
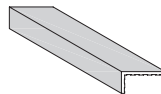
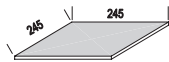
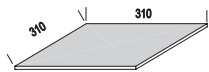

Colour	8830 Extruded tile 310 x 310 x 8 mm		2525 Extruded tile 245 x 245 x 9 mm		482231 Angle tile 310 x 105 x 52 x 8 mm		482245 Angle tile 245 x 105 x 52 x 8 mm	
	Price Group/ Piece		Price Group/ m ²	Price Group/ Piece	Price Group/ m ²	Price Group/ Piece	Price Group/ m ²	Price Group/ Piece
46256 46456 46556 46856 46956	●		□ 195	○ 191	● 232		○ 230	
46257 46357 46857 46557 46957	●		□ 195					
Pieces per m ² /r. m. incl. joints	10			16	3,2		4	
Approx. weight in KG/1000 pcs	1660			1220	840		680	
Pieces per bundle	10			16	8		8	
Pieces per pallet	680			1152	616		672	

● = Standard material ○ = Upon request □ = Pallet discount For colours please see p. 16

Collection MONTANA

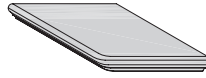
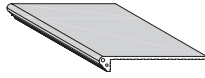

Colour	8835 Florentine stair tile 320 x 310 x 9 mm		883508 Florentine corner stair tile 320 x 320 x 9 mm		8838 Skirting 310 x 73 x 8 mm		883827 Stair skirting, left 883828 Stair skirting, right		8840 Skirting 245 x 73 x 8 mm	
	Price Group/ Piece	Price Group/ m ²	Price Group/ Piece	Price Group/ m ²	Price Group/ Piece	Price Group/ m ²	Price Group/ Piece	Price Group/ m ²	Price Group/ Piece	Price Group/ m ²
46256 46456 46556 46856 46956	● 243		● 272				● 243			
46257 46357 46857	● 243		● 272				● 243			
46255 46355 46455					● 223				○ 223	
46855 46955 46555					● 223				○ 223	
<i>Pieces per m²/r. m. incl. joints</i>		3,2				3,2				4
<i>Approx. weight in KG/1000 pcs</i>		2000		3350		400		1100		300
<i>Pieces per bundle</i>		6		1		34		1		40
<i>Pieces per pallet</i>		204								

● = Standard material ○ = Upon request □ = Pallet discount For colours please see p. 16



NEW!

Collection
COLOSSEO
OUTDOOR

Porcelain stoneware tiles
in concrete look

according to DIN EN 14411 B₁

Examples of appropriate fields of
application in outdoor areas of private,
commercial and public swimming pools
and sports facilities:

- pool surrounds for swimming pools
- terraces
- balconies



8292 Sand cream B/R11



8295 Concrete grey B/R11



8296 Anthracite B/R11

Colour

606020	Porcelain stoneware tile 595 x 595 x 20 mm
Price Group/ Piece	Price Group/ m ²
8292 8295 8296	● <input type="checkbox"/> 209

Pieces per m ² /r. m. incl. joints	2,7778
Approx. weight in KG/1000 pcs	16200
Pieces per bundle	2
Pieces per pallet	64

● = Standard material ○ = Upon request = Pallet discount



NEW!

Collection **CUMULUS**

Porcelain stoneware tiles
in concrete look

according to DIN EN 14411 BI₃

Examples of appropriate fields of application in outdoor areas of private, commercial and public swimming pools and sports facilities:

- pool surrounds for swimming pools
- terraces
- balconies

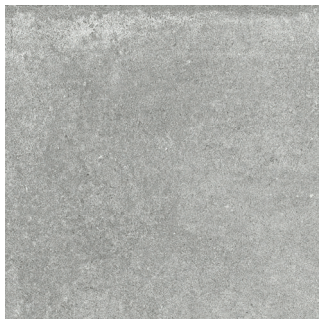

8393 Stone grey B/R11

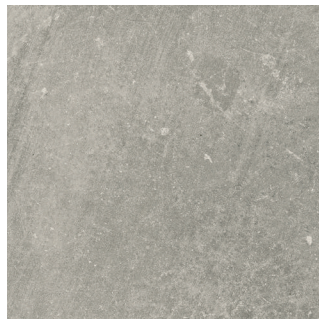

8394 Beige grey B/R11

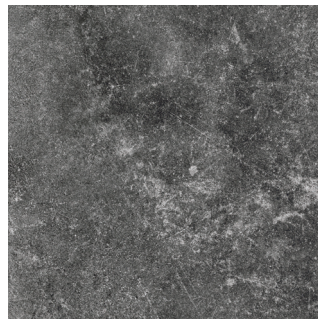

8396 Sky black B/R11

Colour

606020	Porcelain stoneware tile 595 x 595 x 20 mm
Price Group/ Piece	Price Group/ m ²
8393 8394 8396	● <input checked="" type="checkbox"/> 209

Pieces per m ² /r. m. incl. joints	2,7778
Approx. weight in KG/1000 pcs	16200
Pieces per bundle	2
Pieces per pallet	64

● = Standard material ○ = Upon request = Pallet discount



Collection **CONCRET**

Glazed flat extruded stoneware tiles
with a modern, elegant look

according to DIN EN 14411 A1₀

Examples of appropriate fields of
application in outdoor and indoor areas:

- pool surrounds for swimming pools
- elegant floors in commercial and residential areas

Hallenbad Schwarmstedt, Germany
Architekt PGH Hildesheim GmbH



6150 Light beige B/R10



6155 Basalt beige B/R10



6160 Light grey B/R10



6165 Granite grey B/R10

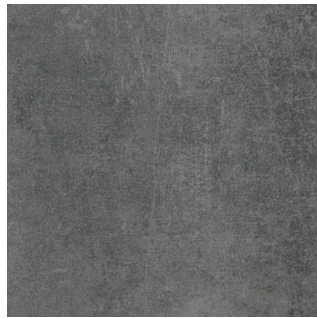

6170 Anthracite B/R10

Colour

3060 Stoneware tile
597 x 297 x 8 mm

303047 Mosaic mat 47 mm
297 x 297 x 8 mm

	Price Group/ Piece	Price Group/ m ²	Price Group/ Piece	Price Group/ m ²
6150 6160 6155 6165 6170		● <input checked="" type="checkbox"/> 198	● 248	
Pieces per m ² /r. m. incl. joints		5,556		11
Approx. weight in KG/1000 pcs		3130		1450
Pieces per bundle		8		11
Pieces per pallet		320		

● = Standard material ○ = Upon request = Pallet discount



Hallenbad Schwarmstedt, Germany
Architekt PGH Hildesheim GmbH



YMCA Aquatic Centre, Brandon, Manitoba, Canada (Carscaden Stokes McDonald Architects Inc.)

Collection COMBI-COLOR I

More than 50 different colours of glazed tiles, strip tiles and accessories with dove tail structure on the back side

according to DIN EN 14411 AI_b

Examples of appropriate fields of application:

- swimming pools
- public, industrial, commercial and private buildings
- walls and facades

Collection COMBI-COLOR I

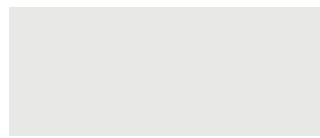

2220 White, glossy; c.g. 2 3



3739 Quartz grey, satin matte; c.g. 5 2



2115 Pale ivory, satin matte; c.g. 3 4



3111 Brown beige, satin matte; c.g. 5 3



5131 Sun yellow, glossy; c.g. 6 2



5321 Orange red, glossy; c.g. 6 1

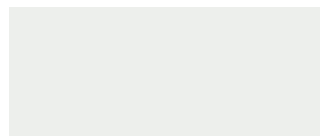

2290 Off white, satin matte; c.g. 2 4



3701 Silver grey, satin matte; c.g. 5 3

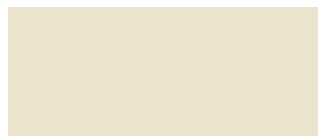

2113 Pearl white, satin matte; c.g. 3 4



3801 Brown ochre, satin matte; c.g. 5 2



3112 Lemon yellow, satin matte; c.g. 5 3



5303 Carmine red, glossy; c.g. 6 1

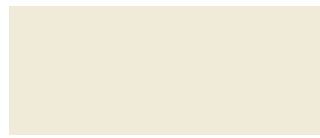

2902 Grey white, satin matte; c.g. 3 4



3731 Blue grey, satin matte; c.g. 5 1



2180 Antique white, vivid, satin matte; c.g. 3 4



3823 Orange brown, satin matte; c.g. 5 2



3102 Sand yellow, satin matte; c.g. 5 4



3304 Purple, glossy; c.g. 5 1



3735 Luminous grey, satin matte; c.g. 3 4



3740 Anthracite, satin matte; c.g. 5 2



2114 Ivory, satin matte; c.g. 3 4



3804 Copper brown, satin matte; c.g. 5 3



3117 Saffron yellow, satin matte; c.g. 5 3



3402 Red violet, glossy; c.g. 5 1



3738 Achate grey, satin matte; c.g. 4 3



3400 Black, glossy; c.g. 5 1



3100 Green beige, satin matte; c.g. 5 3



3825 Pale brown, satin matte; c.g. 5 1



5104 Corn yellow, glossy; c.g. 6 2



3315 Pale pink, glossy; c.g. 5 2



3730 Stone grey, satin matte; c.g. 5 3



3119 Grey beige, satin matte; c.g. 5 3



3815 Chestnut, satin matte; c.g. 5 1



5310 Light orange red, glossy; c.g. 6 2



3401 Lilac red, satin matte; c.g. 5 2



3407 Purple violet, satin matte; c.g. 5 1



3507 Sapphire blue, satin matte; c.g. 5 3



3518 Turquoise blue, satin matte; c.g. 5 2



3605 Moss green, satin matte; c.g. 5 1



5405 Blue violet, satin matte; c.g. 6 2



5515 Azure blue, glossy; c.g. 6 2



3521 Water blue, satin matte; c.g. 5 2



5636 Opal green, glossy; c.g. 6 1



5522 Midnight blue, satin matte; c.g. 6 1



3512 Capri blue, satin matte; c.g. 4 1



3627 Luminous green, satin matte; c.g. 4 3



3613 Reed green, satin matte; c.g. 5 2



3513 Atlantic blue, satin matte; c.g. 5 2



3505 Azure blue, satin matte; c.g. 4 3



3621 Pale green, satin matte; c.g. 4 3



3501 Violet blue, satin matte; c.g. 4 2



3500 Luminous blue, glossy; c.g. 4 3



3619 White green, satin matte; c.g. 4 3



3519 Adria blue, glossy; c.g. 5 2



3514 Dove blue, satin matte; c.g. 5 2



5623 Leaf green, glossy; c.g. 6 1



Lippumäki uimahalli, Kuopio, Finland
(Arkkitehti Sillman Oy Arhitekturbüro)

Collection COMBI-COLOR I

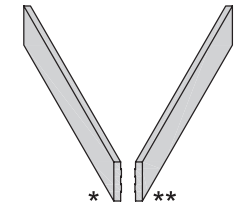
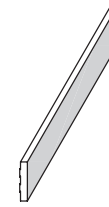
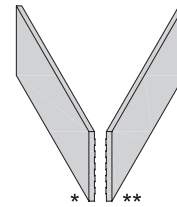
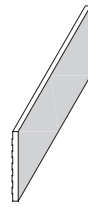

Colour group	Colour	1100 Extruded split tile 240 x 115 x 10 mm		Finished edges 1101 short side 1102 long side 1103 corner, left** 1104 corner, right* 240 x 115 x 10 mm		2120 4/4 Strip tile 240 x 52 x 10 mm		Finished edges 2121 short side 2122 long side 2123 corner, left** 2124 corner, right* 240 x 52 x 10 mm	
		Price Group/ Piece	Price Group/ m ²	Price Group/ Piece	Price Group/ m ²	Price Group/ Piece	Price Group/ m ²	Price Group/ Piece	Price Group/ m ²
2	2220 2290	●	191	●	195	●	200	●	202
3	2114 2115 3735	● ¹	199	○ ¹	201	○ ¹	206	○ ¹	208
	2113 2180 2902	○ ¹	199	○ ¹	201	○ ¹	206	○ ¹	208
4 (colour glazed)	3500	●	197	●	201	○	210	○	211
	3505	●	201	●	203	○	210	○	211
	3501 3512 3619 3621 3627 3738	○ ¹	201	○ ¹	203	○ ¹	210	○ ¹	211
5 (colour glazed)	3100 3102 3111 3112 3117 3119	○ ¹	209	○ ¹	210	○ ¹	211	○ ¹	212
	3304 3315 3401 3402 3407 3507								
	3514 3518 3519 3521 3605 3613								
	3700 3701 3730 3731 3739 3801								
	3804 3815 3823 3825								
	3400 3740 3513	●	209	○	210	○	211	○	212
6	5104 5131 5303 5310 5321 5405	● ¹	214	○ ¹	215	○ ¹	215	○ ¹	215
	5515 5522 5623 5636								
		Pieces per m ² /r. m. incl. joints	33	33	67	67			
		Approx. weight in KG/1000 pcs	600	600	280	280			
		Pieces per bundle	25	25	50	50			
		Pieces per pallet	1800	1800	3600	3600			

● = Standard material ○ = Upon request □ = Pallet discount For colours please see p. 26-27 ¹ Prices might be higher for small quantities.

Useful information

For laying with 6 mm joint width see collection »Combi-Color II«.

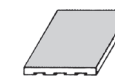
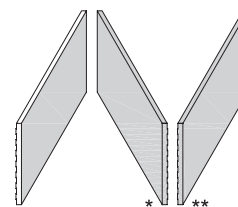
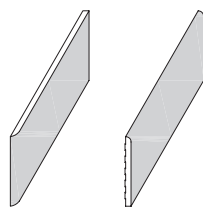

(Twin tile - to be split on site)

Colour group	Colour	Rounded on		1150 Extruded split tile Finished edges		1200 Extruded split tile Finished edges	
		Price Group/ Piece	Price Group/ m ²	Price Group/ Piece	Price Group/ m ²	Price Group/ Piece	Price Group/ m ²
2	2220	● 225		● 225		● 204	
	2290	● 225		● 225		● 204	
4/5 (glazed plain colours)	3500 3513	● 227		● 230		● 211	
	3512 3518 3521 3627	○ 227		○ 230		○ ¹ 211	
More colours upon request							
Pieces per m ² /r. m. incl. joints		8		26		66	
Approx. weight in KG/1000 pcs		600		860		290	
Pieces per bundle		25		24		50	
Pieces per pallet		1800		1440		3600	

● = Standard material ○ = Upon request □ = Pallet discount For colours please see p. 26-27 ¹ Prices might be higher for small quantities.

Useful information

For laying with 6 mm joint width see collection »Combi-Color II«.

Collection COMBI-COLOR I

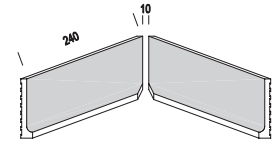
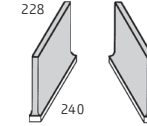
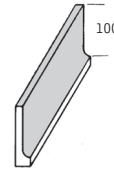
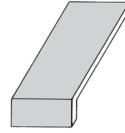
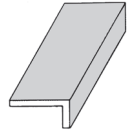

Colour group	Colour	4822 Angle tile 240/52 x 115 x 10 mm		4811 Angle tile 240 x 115/52 x 10 mm		4000 Cove skirting (square top) 240 x 100 x 10/20 mm		4001 Cove skirting, external angle, left 4002 Cove skirting, external angle, right 228/240 x 100 mm		400503 Internal mitre, left 400504 Internal mitre, right 240 x 100 x 10/20 mm	
		Price Group/ Piece	Price Group/ m ²	Price Group/ Piece	Price Group/ m ²	Price Group/ Piece	Price Group/ m ²	Price Group/ Piece	Price Group/ m ²	Price Group/ Piece	Price Group/ m ²
2	2220 2290	● 234		○ 238		● 229		● 236 (Piece)		● 237 (Piece)	
More colours upon request											
<i>Pieces per m²/r. m. incl. joints</i>		4		8		4				493	
<i>Approx. weight in KG/1000 pcs</i>		900		720		580		280			
<i>Pieces per bundle</i>		10		10		20		20		20	
<i>Pieces per pallet</i>		600		600		1400		1296		1500	

● = Standard material ○ = Upon request □ = Pallet discount For colours please see p. 26-27

Useful information

For laying with 6 mm joint width see collection »Combi-Color II«.

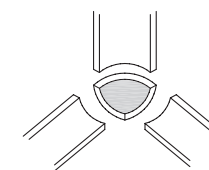
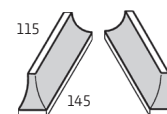
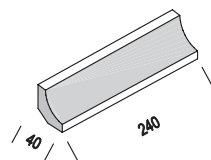
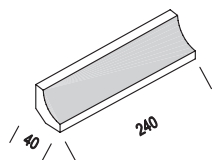

Colour group	Colour	4100 Cove 240 x 40 x 40 x 7,5 mm		4101 Cove, end piece 240 x 40 x 40 x 7,5 mm		4203 Cove, external angle, left 4204 Cove, external angle, right 115/145 x 40 x 40 x 7,5 mm		4102 Cove, internal angle 40 x 40 x 40 x 7,5 mm	
		Price Group/ Piece	Price Group/ m ²	Price Group/ Piece	Price Group/ m ²	Price Group/ Piece	Price Group/ m ²	Price Group/ Piece	Price Group/ m ²
2	2220 2290	● 229		● 232		● 236 (Piece)		● 236	
4 (colour glazed)	3500	● 231		● 234		● 238 (Piece)		● 238	
More colours upon request									
	Pieces per m ² /r. m. incl. joints	4		344		137		130	
	Approx. weight in KG/1000 pcs	344		344		137		130	
	Pieces per bundle	48		48		32		108	
	Pieces per pallet	3456		3456		3456		3456	

● = Standard material ○ = Upon request □ = Pallet discount For colours please see p. 26-27

Useful information

For laying with 6 mm joint width see collection »Combi-Color II«.



Waerket Thyboron Vandkulturhaus, Denmark

Collection **COMBI-COLOR II**

More than 50 different pastel colours of glazed dry-pressed tiles and flat-extruded tiles

according to DIN EN 14411 BI₆ and DIN EN 14411 AI₆

Examples of appropriate fields of application:

- swimming pools
- on walls of public, industrial, commercial and private buildings

Collection COMBI-COLOR II

Contrast colours and various colours in satin matte and glossy finish



2020 White, glossy



30735 Luminous grey



20115 Pale ivory



30113 Broom yellow



30804 Copper brown



30519 Adriatic blue



2090 Off white



30738 Achate grey



30102 Sand yellow



30112 Lemon yellow



30805 Chocolate brown



30501 Violet blue



30740 Anthracite



30701 Silver grey



20114 Ivory



30119 Grey beige



30806 Nougat



30507 Sapphire blue

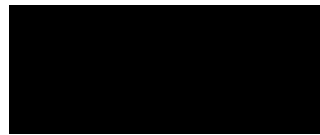

30404 Black, satin



30731 Blue grey



30314 Champagne



30117 Saffron yellow



30807 Nut brown



30514 Dove blue



30400 Black, glossy



30315 Pale pink



50104 Corn yellow



30814 Mahogany brown



30511 Syringa blue



30110 Light yellow



30823 Orange brown



30815 Chestnut



30510 Pastel blue



30500 Luminous blue, glossy



30622 Apple green



50522 Midnight blue, glossy



30502 Light blue



30627 Luminous green



50622 Spring green



30505 Azure light blue



30619 White green



50132 Lime



50515 Azure blue



30536 Aquamarine



50131 Sun yellow



30513 Atlantic blue



30521 Water blue



50310 Light orange red



30540 Anthracite blue, glossy



30518 Turquoise blue



50303 Carmine red

Vibrant glossy colours

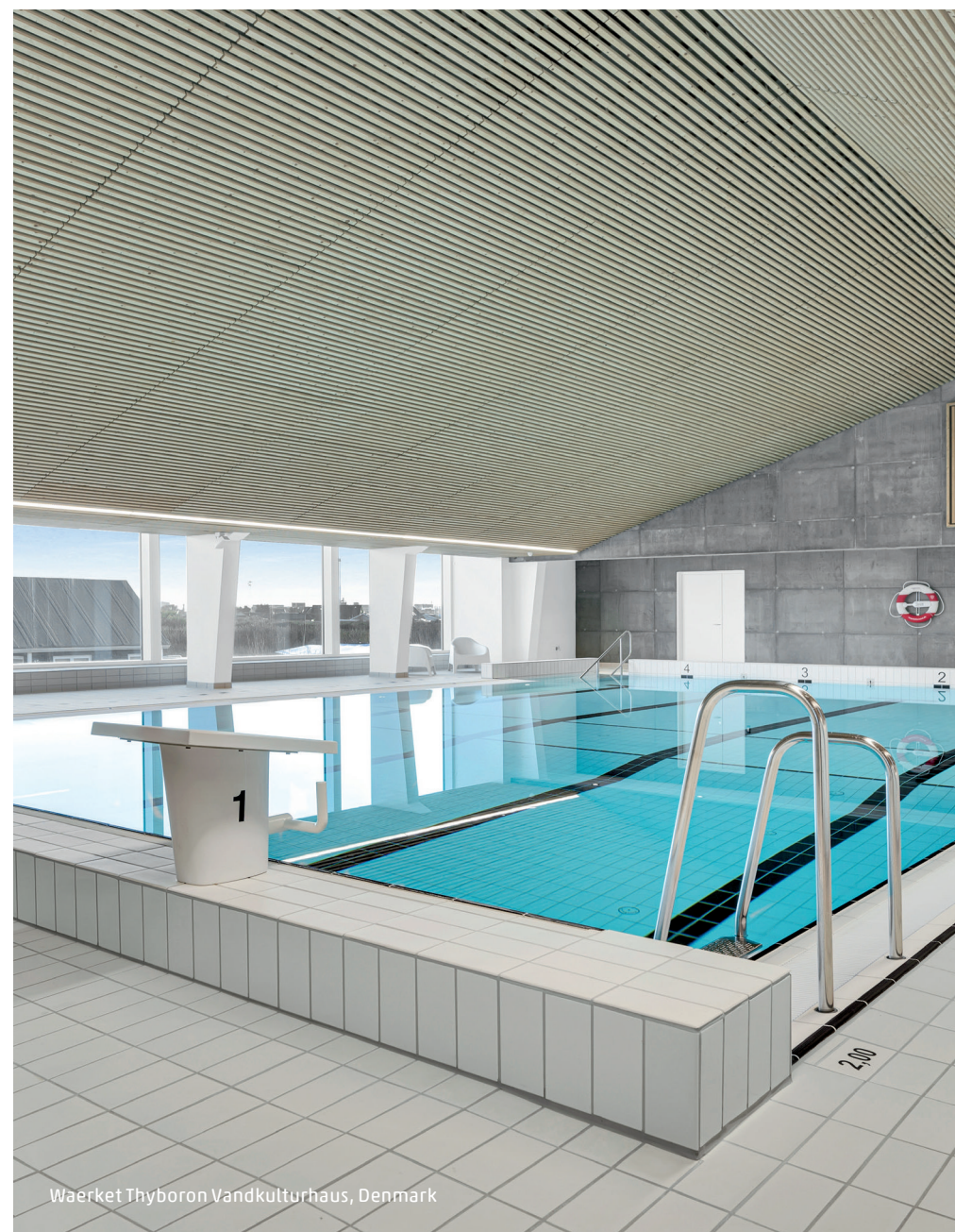

Waerket Thyboron Vandkulturhaus, Denmark

Collection COMBI-COLOR II

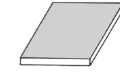
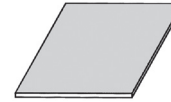
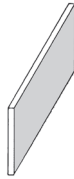

(Twin tile -
to be split on site)

Colour group	Colour	11004T Glazed ceramic dry-pressed tile 244 x 119 x 7,5 mm (Also available as flat extruded tiles)	161044 Extruded tile 244 x 244 x 7,5 mm	120044 Extruded tile 119 x 119 x 7,5 mm	
		11014T short side 11024T long side 11034T corner, left 11044T corner, right			
		Price Group/ Piece	Price Group/ m ²	Price Group/ Piece	Price Group/ m ²
I	2020 2090	● 189	○ 201	○ 205	
II	30500	● 190	○ 202	○ 208	
III	30513	● 199	○ 204	○ 210	
IV	20114 20115 30502 30735	● 206	○ 208	○ 210	
V	30102 30110 30112 30113 30117 30119 30314 30315 30400 30404 30501 30505 30507 30510 30511 30514 30518 30519 30521 30536 30540 30619 30622 30627 30701 30731 30738 30740 30804 30805 30806 30807 30814 30815 30823 50104 50515	● 208	○ 209	○ 210	
VI	50131 50132 50303 50310 50522 50622	● 212	○ 212	○ 213	
More colours upon request					
	Pieces per m ² /r. m. incl. joints	32	16	64	
	Approx. weight in KG/1000 pcs	460	930	230	
	Pieces per bundle	40	20	80	
	Pieces per pallet	2760	1440	5760	

● = Standard material ○ = Upon request = Pallet discount For colours please see p. 34-35

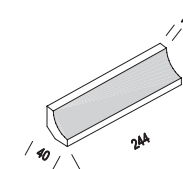
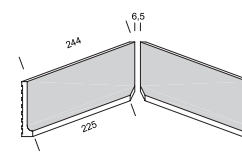
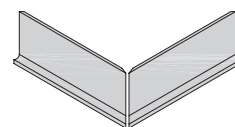
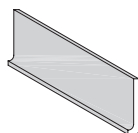

Colour group	Colour	400044 Cove skirting (square top) 244 x 100 x 6,5/16,5 mm		400144 Cove skirting, external angle, left 400244 Cove skirting, external angle, right 244 x 100 x 6,5 mm		400503 Internal mitre, left 400504 Internal mitre, right 244 x 100 x 6,5 mm		410044 Cove 244 x 40 x 40 x 7,5 mm	
		Price Group/ Piece	Price Group/ m ²	Price Group/ Piece	Price Group/ m ²	Price Group/ Piece	Price Group/ m ²	Price Group/ Piece	Price Group/ m ²
I	2020 2090	● 229		● 236 (Piece)		● 237 (Piece)		● 229	
II	30500	● 232		○ 237		○ 237		● 231	
III	30513	● 232		○ 237		○ 237		○ 232	
IV	20114 20115 30502 30735	● 232		○ 237		○ 237		○ 232	
V	30102 30110 30112 30113 30117 30119 30314 30315 30400 30404 30501 30505 30507 30510 30511 30514 30518 30519 30521 30536 30540 30619 30622 30627 30701 30731 30738 30740 30804 30805 30806 30807 30814 30815 30823 50104 50515	● 232		○ 237		○ 237		○ 232	
VI	50131 50132 50303 50310 50522 50622								
More colours upon request									
Pieces per m ² /r. m. incl. joints		4		505		493		4	
Approx. weight in KG/1000 pcs		580		20		20		349	
Pieces per bundle		20		1296		1500		48	
Pieces per pallet		1400						3456	

● = Standard material ○ = Upon request □ = Pallet discount For colours please see p. 34-35

Collection COMBI-COLOR II

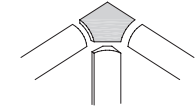
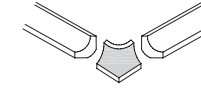
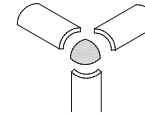
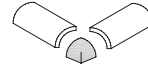
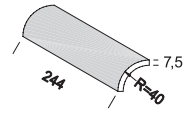

Colour group	Colour	945044 Radial tile R 40 x 244 x 7,5 mm		945064 Convex bead with 2 connec- tions for radial tile 945044		945061 Convex bead with 3 connec- tions for radial tile 945044		945067 Convex cove for radial tile 945044 and cove 410044		945068 Internal mitre angle for radial tile 945044 and cove 410044	
		Price Group/ Piece	Price Group/ m ²	Price Group/ Piece	Price Group/ m ²	Price Group/ Piece	Price Group/ m ²	Price Group/ Piece	Price Group/ m ²	Price Group/ Piece	Price Group/ m ²
I	2020 2090	● 231		● 246		● 246		● 247		● 251	
II	30500	● 234		● 247		● 247		● 248		● 252	
III	30513	● 234		● 247		● 247		● 248		● 252	
IV	20114 20115 30502 30735	○ 234		○ 247		○ 247		○ 249		○ 254	
V	30102 30110 30112 30113 30117 30119 30314 30315 30400 30404 30501 30505 30507 30510 30511 30514 30518 30519 30521 30536 30540 30619 30622 30627 30701 30731 30738 30740 30804 30805 30806 30807 30814 30815 30823 50104 50515	○ 234		○ 247		○ 247		○ 249		○ 254	
VI	50131 50132 50303 50310 50522 50622	○ 238		○ 247		○ 247		○ 249		○ 254	
More colours upon request											
<i>Pieces per m²/r. m. incl. joints</i>		4		60		27		100		100	
<i>Approx. weight in KG/1000 pcs</i>		300		60		27		100		100	
<i>Pieces per bundle</i>		50		60		27		100		100	
<i>Pieces per pallet</i>		3000		600		270		1000		1000	

● = Standard material ○ = Upon request □ = Pallet discount For colours please see p. 34-35



Lippumäki uimahalli, Kuopio, Finland
(Arkkitehti Sillman Oy Architekturbüro)

Collection **GRIP-STAR SOFT SP I**

Glazed and unglazed extruded tiles
with slip-resistant properties
for dry and wet areas

according to DIN EN 14411 A1₀

Examples of appropriate fields of application:

- in areas with an increased risk
of slipping, eg swimming pools,
laboratories, commercial and industrial
buildings

Collection GRIP-STAR SOFT SP I



35956 Luminous blue, matte B/R 11 4

35957 Luminous blue, matte C/R 12 4



36276 Luminous green, matte B/R 11 3

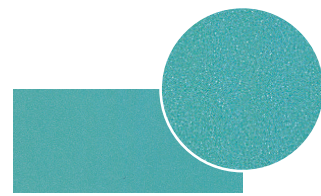

35186 Turquoise blue, matte B/R 11 2

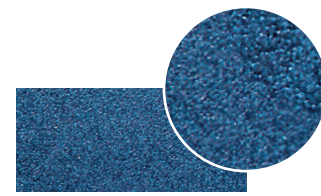

35136 Atlantic blue, matte B/R 10 2

35137 Atlantic blue, matte C/R 12 2



35126 Capri blue, matte B/R 11 2



35216 Water blue, matte B/R 11 2

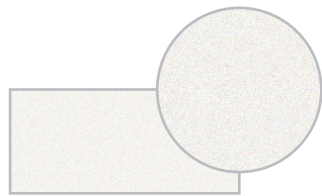

22106 White, matte B/R 11 4

22107 White, matte C/R 12 4

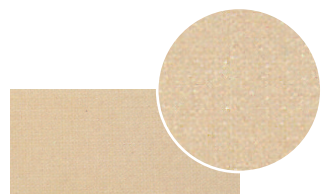

22936 Light cream, matte B/R 11 4

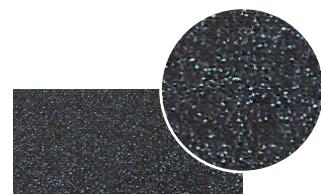

37406 Anthracite, matte B/R 10 2

37407 Anthracite, matte C/R 12 2

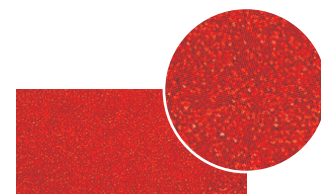

53035 Carmine red, matte A/R 11 2

53036 Carmine red, matte B/R 11 2



51315 Sun yellow, matte A/R 11 3

51316 Sun yellow, matte B/R 11 3

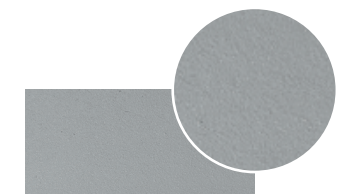

37356 Light grey, matte B/R 11 3

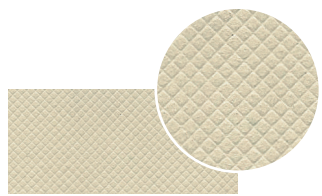

1030 Grey cream, checked surface finish C/R 13 U

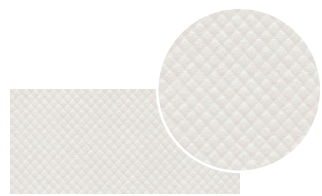

22106 White, checked surface finish C/R 12 4

Useful information

More colours of the collection »Combi-Color I« are available in slip-resistance B/R 10 upon request.

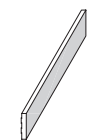
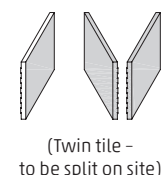
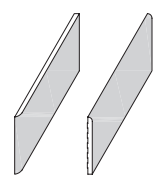
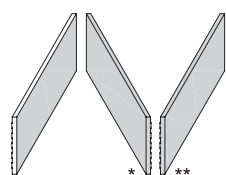

Colour	1100 Antislip extruded split tile 1101 short side 1102 long side 1103 corner, left** 1104 corner, right* 240 x 115 x 10 mm		1105 Rounded on short side 1106 Rounded on long side 1107 Rounded on corner, left 1108 Rounded on corner, right 240 x 115 x 10 mm		1200 Antislip extruded split tile 1201 border 1203 corner 115 x 115 x 10 mm		2120 4/4 Strip tile 240 x 52 x 10 mm		
	Price Group/ Piece	Price Group/ m ²	Price Group/ Piece	Price Group/ m ²	Price Group/ Piece	Price Group/ m ²	Price Group/ Piece	Price Group/ m ²	
22106	●	202	●	227	●	208	●	214	
35956		●	209		●	212	●	214	
22107 35136		●	209	●	230	●	212	●	214
51315 51316 53035 53036		●	215		●	215	●	215	
22936 35126 35137 35186 35216 35957 36276 37356 37407		○ ¹	210	●	232	●	213		
37406		○ ¹	210	●	232	●	213	●	215
Pieces per m ² /r. m. incl. joints		33		8		66		67	
Approx. weight in KG/1000 pcs		600		600		290		280	
Pieces per bundle		25		25		50		50	
Pieces per pallet		1800		1800		3600		3600	

● = Standard material ○ = Upon request □ = Pallet discount For colours please see p. 40 ¹ Prices might be higher for small quantities.

Collection GRIP-STAR SOFT SP I

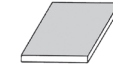
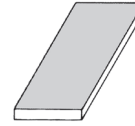
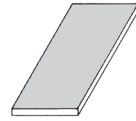

(Twin tile -
to be split on site)

Colour		110042 Extruded split tile with checked surface finish 110142 short side 110242 long side 110342 corner, left 110442 corner, right 240 x 115 x 10 mm	111042 Extruded split tile with checked surface finish 240 x 115 x 18 mm	120042 Extruded split tile with checked surface finish 115 x 115 x 10 mm	
		Price Group/ Piece	Price Group/ m ²	Price Group/ m ²	Price Group/ m ²
unglazed	1030	● 208	○ 211	○	
	(1000)	● 201			
glazed	22106	● 203		○	
	<i>Pieces per m²/r. m. incl. joints</i>	33	33	66	
	<i>Approx. weight in KG/1000 pcs</i>	600	1078	290	
	<i>Pieces per bundle</i>	25	12	50	
	<i>Pieces per pallet</i>	1800	864	3600	

● = Standard material ○ = Upon request □ = Pallet discount For colours please see p. 40



Schloss Warnsdorf bei Travemünde, Germany

Collection GRIP-STAR SOFT SP II

Glazed and unglazed extruded, flat-extruded and dry-pressed tiles with slip-resistant properties for dry and wet areas

according to DIN EN 14411 BI₀ and DIN EN 14411 AI₀

Examples of appropriate fields of application:

- areas with increased risk of slipping such as swimming pools

Collection GRIP-STAR SOFT SP II

Glazed



202106 White satin matte B/R11
202107 White satin matte C/R12



307356 Luminous grey B/R11



304046 Anthracite B/R10
304047 Anthracite C/R12

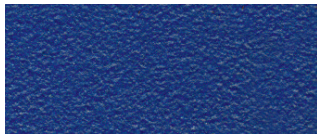

305136 Atlantic blue B/R10
305137 Atlantic blue C/R12



505156 Azure blue B/R11



305956 Luminous blue B/R11
305957 Luminous blue C/R12



305366 Aquamarine B/R11



305186 Turquoise blue B/R11



306226 Apple green B/R11



501326 Lime B/R11



501316 Sun yellow B/R11



503036 Carmine red B/R11

Unglazed



1031 Grey cream B/R10* U



103142 Grey cream C/R11* U



1001 White grey B/R10* U



100142 White grey C/R11* U

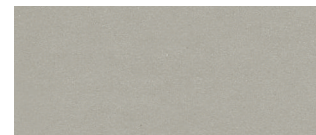

1701 Lightgrey B/R10* U

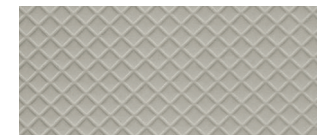

170142 Lightgrey C/R11* U

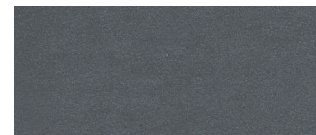

1731 Anthracite B/R10* U

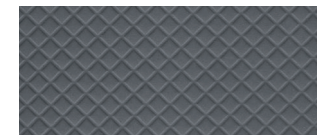

173142 Anthracite C/R11* U

* With an easy-to-clean surface treatment

Useful information

More colours of the Collection Combi-Color II are available in slip-resistance B/R10 upon request.

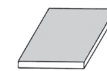
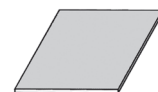
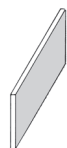

(Twin tile - to be split on site)

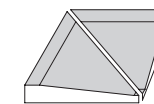
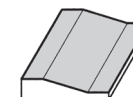

Colour	11004T Glazed ceramic dry-pressed tile <small>(Also available as flat extruded tiles)</small>		110544 Rounded on short side 110644 Rounded on long side 110744 Rounded on corner, left 110844 Rounded on corner, right 244 x 119 x 7,5 mm		161044 Extruded tile 244 x 244 x 7,5 mm		120044 Extruded tile 119 x 119 x 7,5 mm		4720 Shower basin tile 119 x 119 x 18/7,5 mm		472003 Corner 119 x 119 x 18/7,5 mm	
	Price Group/ Piece	Price Group/ m ²	Price Group/ Piece	Price Group/ m ²	Price Group/ Piece	Price Group/ m ²	Price Group/ Piece	Price Group/ m ²	Price Group/ Piece	Price Group/ m ²	Price Group/ Piece	Price Group/ m ²
202106	●	200	●	227	○	204	○	210	○	247	○	252
305136 307356	●	205	●	230	○	208	○	210				
305956	●	202	●	230	○	207	○	208				
1001 1031 1701 1731	●	202	●	232	○	206	○	208				
100142 103142 170142 173142	●	206			○	208	○	210				
202107	●	200										
305957	●	204										
304046 304047 305137 305186 305366 306226 501316 501326 503036 505156	●	210										
Pieces per m ² /r. m. incl. joints		32		8		16		64		8		
Approx. weight in KG/1000 pcs		460		460		930		230		410		450
Pieces per bundle		40		32		20		80		44		36
Pieces per pallet		2760				1440		5760		2640		2160

● = Standard material ○ = Upon request □ = Pallet discount For colours please see p. 44

Collection GRIP-STAR SOFT SP II

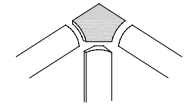
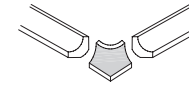
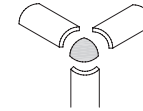
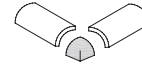
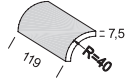
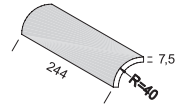
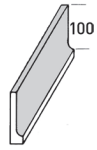

Colour	400044 Cove (square top) 244 x 100 x 10/20 mm		945044 Radial tile R 40 x 244 x 7,5 mm		945544 1/2 Radial tile R 40 x 119 x 7,5 mm		945064 Convex bead with 2 connections for radial tile 945044		945061 Convex bead with 3 connections for radial tile 945044		945067 Convex cove for radial tile 945044 and cove 410044		945068 Internal mitre angle for radial tile 945044 and cove 410044	
	Price Group/ Piece	Price Group/ m ²	Price Group/ Piece	Price Group/ m ²	Price Group/ Piece	Price Group/ m ²	Price Group/ Piece	Price Group/ m ²	Price Group/ Piece	Price Group/ m ²	Price Group/ Piece	Price Group/ m ²	Price Group/ Piece	Price Group/ m ²
202106	○ 232		● 234		● 232		● 247		● 247		● 248		● 252	
305136			● 234		● 232		● 247		● 247		● 249		● 254	
305956			● 234		● 232		● 247		● 247		● 249		● 254	
1001 1031 1701 1731	○ 232		○ 234		○ 232		○ 247		○ 247		○ 249		○ 254	
Pieces per m ² /r. m. incl. joints	4		4		8		60		27		100		100	
Approx. weight in KG/1000 pcs	560		300		150									
Pieces per bundle	20		50		100									
Pieces per pallet	1400													

● = Standard material ○ = Upon request □ = Pallet discount For colours please see p. 44



Reha Klinik Pankow, Germany

Collection MOSAIC

Glazed dry-pressed mosaic tiles,
glued on net, with glossy, matte
or slip-resistant surface

according to DIN EN 14411 Bl₆

Examples of appropriate fields of application:

- swimming pools
- public, industrial and commercial property
- private residential construction
- and much more

Collection MOSAIC

Our main colours



22908 White, matte
229086 White, matte B/R10



35008 Luminous blue, glossy
350086 Luminous blue, glossy B/R10

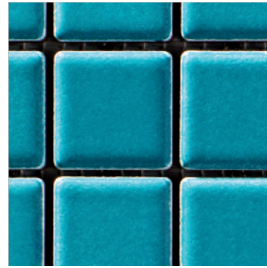

35188 Turquoise blue, satin matte

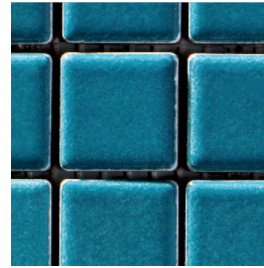

35218 Water blue, satin matte



36198 White green, satin matte



36278 Luminous green, satin matte

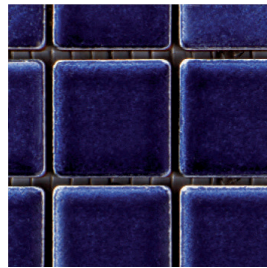

35138 Atlantic blue, satin matte

Endless possibilities, here a short selection:

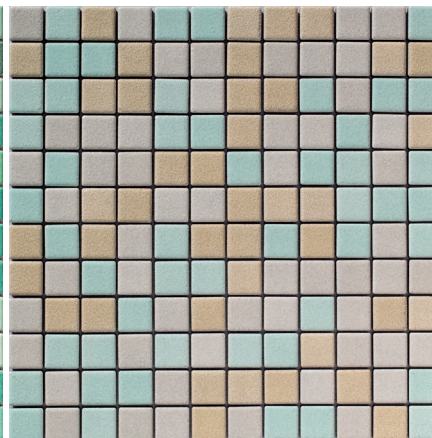
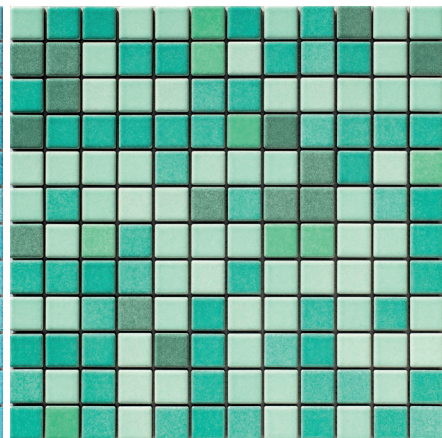
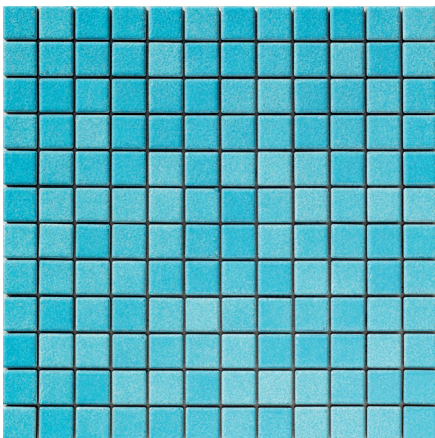

Reha Klinik Pankow, Germany

Individual colour combinations (colour combination 99999 - see page 49) · Vivid colours available upon request

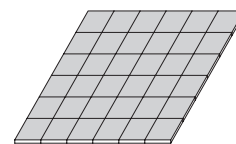
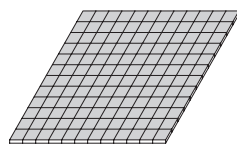

Colour	0101 Dry pressed tiles 11,5 x 11,5 x 7,2 mm glued on net 298 x 298 mm		0202 Dry pressed tiles 23,4 x 23,4 x 7,2 mm glued on net 298 x 298 mm		0202 Glued on the face side	
	Price Group/ Piece	Price Group/ m ²	Price Group/ Piece	Price Group/ m ²	Price Group/ Piece	Price Group/ m ²
22908		● 290		● 210		○ 211
35008 35138 35188 35218 36198 36278		● 291		● 211		○ 212
Colour combination 99999		● 292		● 213		○ 214
229086 350086				● 214		
Pieces per m ² /r. m. incl. joints	11		11			
Approx. weight in KG/1000 pcs	1250		1323			
Pieces per bundle	14		14			
Pieces per pallet	672		672			

● = Standard material ○ = Upon request □ = Pallet discount For colours please see p. 48

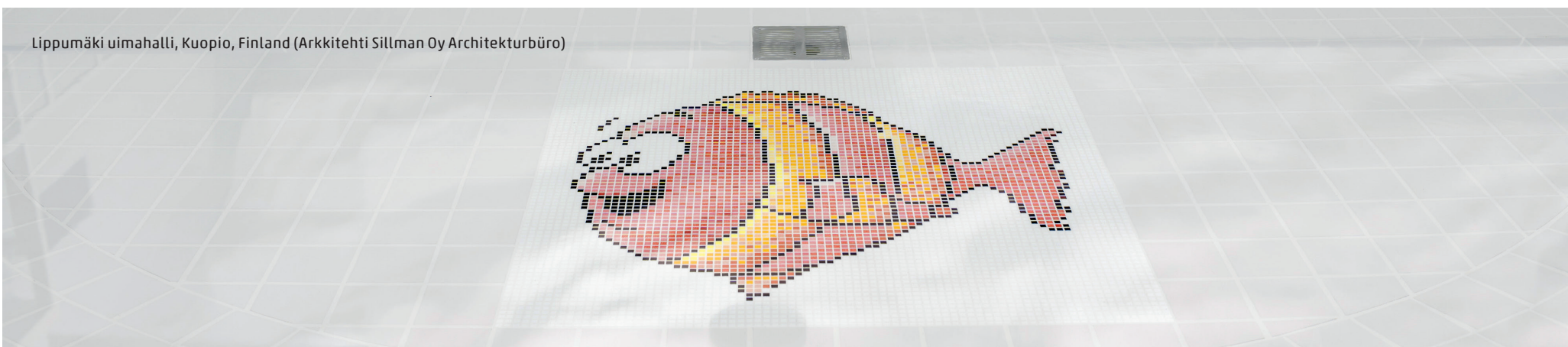



Nationaal Zwemcentrum de Tongelreep, Eindhoven, Netherlands

Collection **PREMIER I**

Glazed dry pressed tiles, in
pastel and brilliant colours

according to DIN EN 14411 BI₀

Examples of appropriate fields of application:

- swimming pools
- public, industrial and commercial
commercial property areas
- private residential construction,
eg also in bathrooms and kitchens

Collection PREMIER I



8734 Black



8751 Dark grey



8722 Medium grey



8719 Light grey

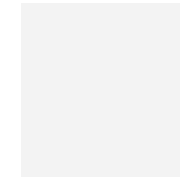

8720 White



5303 Carmine red



8746 Orange



8752 Yellow



8753 Cotto



8728 Caramel



8741 Sand yellow



8727 Cream



8749 Moss green



8748 Turquoise green



8724 Grey-green



8743 Pacific blue



8736 Accent blue



8732 Light blue

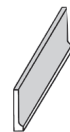

Colour	2020 Dry pressed tile 197 x 197 x 6 mm		202860 Dry pressed cover 197 x 97 x 6 mm		202863 External angle 97 x 30 x 6 mm		202864 Internal angle 97 x 30 x 6 mm	
	Price Group/ Piece	Price Group/ m ²	Price Group/ Piece	Price Group/ m ²	Price Group/ Piece	Price Group/ m ²	Price Group/ Piece	Price Group/ m ²
8719		○ 195						
8720		○ 195	○ 232		○ 234		○ 234	
8722 8751 8724 8727 8732 8736 8741 8743		○ 196						
8748 8749 8752		○ 201						
8728 8734		○ 203						
8746 8753		○ 208						
5303		○ 212						
Pieces per m ² /r. m. incl. joints	25		5		50		50	
Approx. weight in KG/1000 pcs	518		160		50		50	
Pieces per bundle	25		50		100		100	
Pieces per pallet	2100		3600					

● = Standard material ○ = Upon request □ = Pallet discount For colours please see p. 52

NEW!

Collection **PREMIER II**

Glazed dry pressed tiles, in
pastel and brilliant colours

according to DIN EN 14411 BI₀

Examples of appropriate fields of application:

- swimming pools
- public, industrial and commercial
commercial property areas,
eg commercial kitchens
- private residential construction

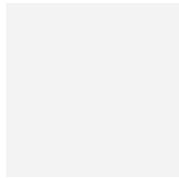

8720 White, matte



8748 Turquoise



8754 Azure blue



8756 Dark blue

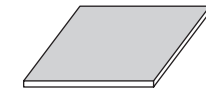
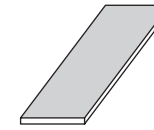
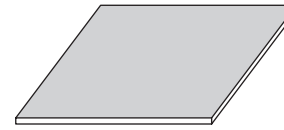

Colour

3030 Dry pressed tile
297 x 297 x 7 mm

1030 Dry pressed tile
297 x 97 x 7 mm

2020 Dry pressed tile
197 x 197 x 6 mm

Colour	3030 Dry pressed tile 297 x 297 x 7 mm		1030 Dry pressed tile 297 x 97 x 7 mm		2020 Dry pressed tile 197 x 197 x 6 mm	
	Price Group/ Piece	Price Group/ m ²	Price Group/ Piece	Price Group/ m ²	Price Group/ Piece	Price Group/ m ²
8720		○ 199		○ 196		○ 195
8748		○ 201		○ 201		○ 201
8754		○ 200		○ 200		○ 196
8756		○ 201		○ 201		○ 200
<i>Pieces per m²/r. m. incl. joints</i>	11		33		25	
<i>Approx. weight in KG/1000 pcs</i>	1344		435		518	
<i>Pieces per bundle</i>	15		50		25	
<i>Pieces per pallet</i>	750		2400		2100	

● = Standard material ○ = Upon request □ = Pallet discount For colours please see p. 56

SPECIAL-FORM

Glazed plain colours



3500 Luminous blue, glossy*
35956 Luminous blue, satin matte B/R 10



3505 Azure blue, satin matte



3512 Capri blue, satin matte*



3513 Atlantic blue, satin matte
35136 Atlantic blue, satin matte B/R 10



3627 Luminous green, satin matte*



3518 Turquoise blue, satin matte*



3521 Water blue, satin matte*



3740 Anthracite, satin matte
37406 Anthracite, satin matte B/R 10

Glazed plain colours

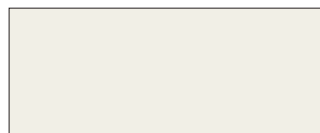

2290 Off white, satin matte

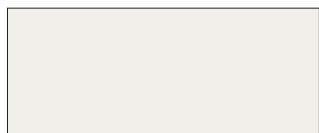

2220 White, glossy



22106 White, matte B/R 11



2115 Pale ivory, satin matte

Unglazed plain colour



1030 Grey cream B/R 11



3130; 1030 Grey cream C/R 11 V 8

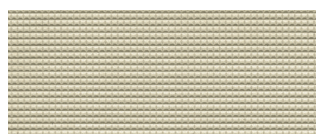

3170; 1030 Grey cream C/R 12 V 6

* These colours are listed with a skid preventing surface in our collection »Grip-Star Soft SP I« on page 40.

Useful information

Collection »Special-Form« is also available in all colours of collections »Combi-Color I« and »Combi-Color II« upon request.



Poseidon Therme, Ischia, Italy

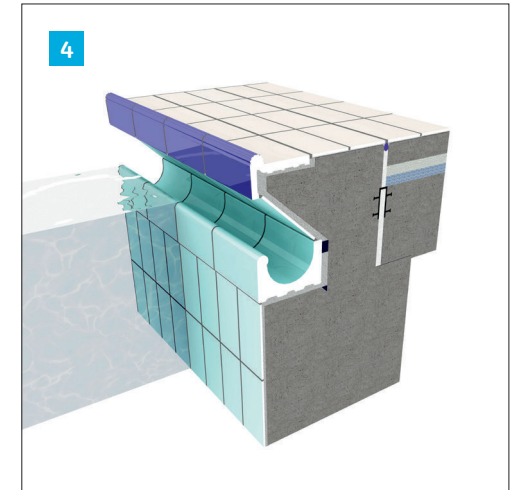
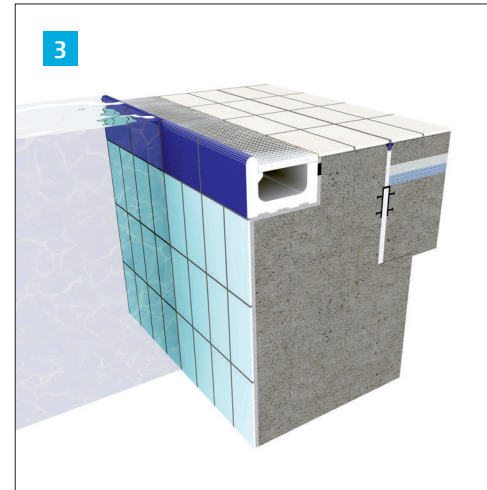
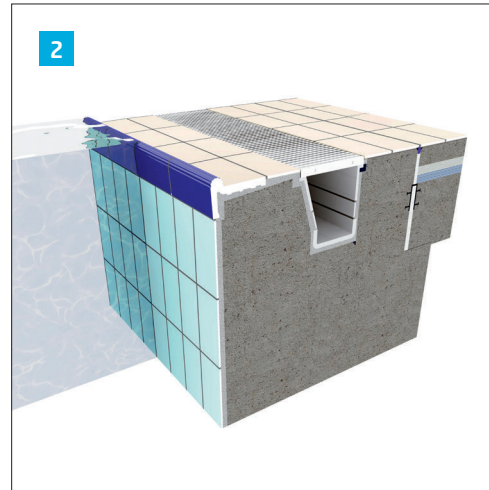
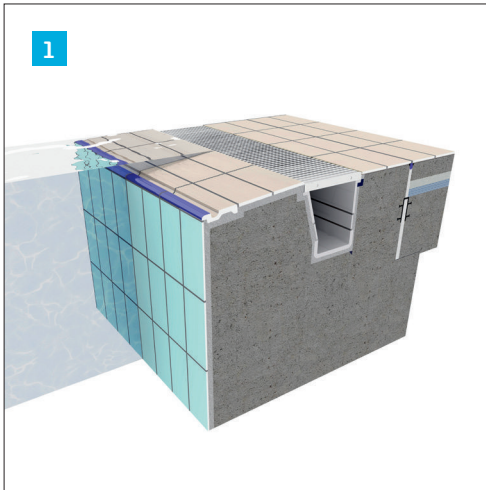

The »Finnish Channel«

Calm water levels and good visibility:

The main feature is the inclined level rising from the pool wall towards the overflow channel and the grooved hand-grip tile with safety markings. The water runs up like on a beach and the water level quickly calms down as a result. Further advantages: (a) water level at or above the level of the pool deck, (b) excellent visibility for bathers and pool attendants, (c) no chlorine blanket above the pool, so no unpleasant odours, (d) cleaning the drainage channel from the pool deck, and (e) savings on excavation and concrete work, as the pool can be up to approx. 30 cm lower with the same water depth than with a so-called low-lying water level with a channel inside the pool.

The »Zurich Channel«

Wider pool surround and less construction work:

A pool edging tile serves as an overflow edge, with a directly adjacent overflow channel or an overflow channel behind it. The water level is at or above the level of the pool deck, which provides excellent visibility and no odour nuisance from chlorine. The pool deck can be used from the edge, and excavation and concrete work are comparatively inexpensive.

The high level »Wiesbaden Channel«

Good grip for swimmers and easy-to-clean:

A typical feature is the overflow channel with its dual purpose protruding edge that acts as an overflow and handhold in one. The water level here is also at or above the level of the pool surround, and there is no chlorine blanket. Equally important: the pool edge has good holding options for swimmers, the drainage channel can be cleaned from the pool deck, and full use of pool deck is available from the edge. Here, too, there is potential for savings in the shell construction.

The low level »Wiesbaden Channel«

Good wave breaking and ideal for renovation of historic baths:

This system consists of an internal overflow channel located approx. 0.30 m below the pool deck. As a result, the water level is lower. The most important advantages of this system: good wave breaking due to the sloping tile, good holding options on the channel lip, clearly visible markings, and good attachment options for lane ropes.

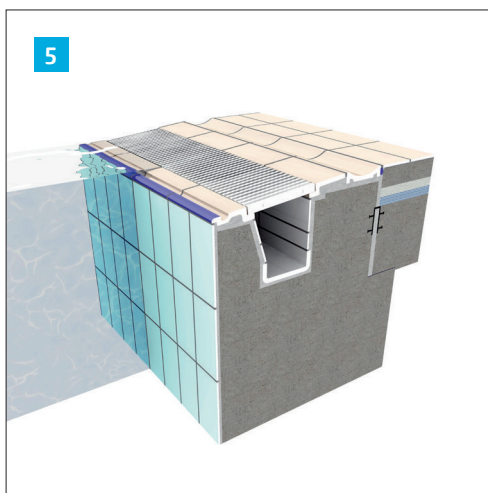

The »Finnish Channel« with grating rest

Customisable channel dimensions:

A grip tile with a double function opens up a great deal of freedom to design the drainage channel individually in terms of width and depth. This is because the moulded part also serves as a support for the cover grate. A shallow channel behind the pool head also supports drainage.

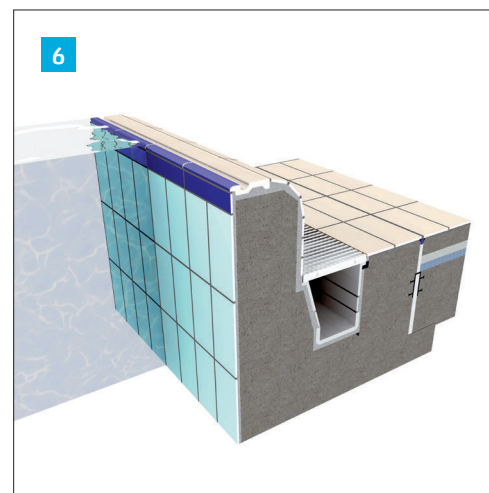

The »St. Moritz Channel«

Good visibility thanks to high water level:

The St Moritz channel is characterised by a raised pool wall over which the water flows into the surrounding channel. The high water level allows a view far beyond the edge of the pool, making the St Moritz channel particularly suitable for the design of therapy pools as well as hotel and leisure pools. Because the pool requires less excavation, the construction costs are also reduced.

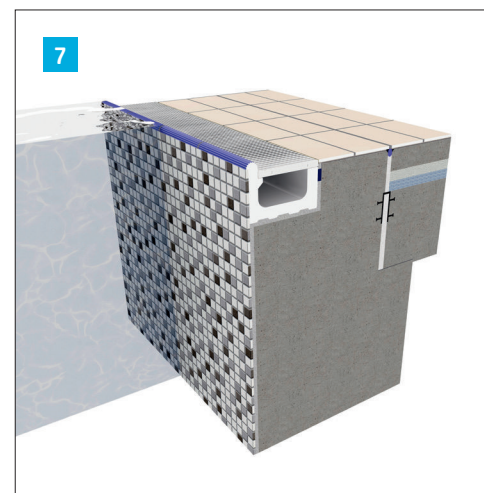

The »Wiesbaden Channel« with recess

Greater freedom for designing pool walls:

An additional recess on the tried-and-tested Wiesbaden Channel creates space for lining the basin with mosaic tiles. This opens up unlimited possibilities for planners and builders to create individual colour schemes. A contemporary symbiosis of function and design!

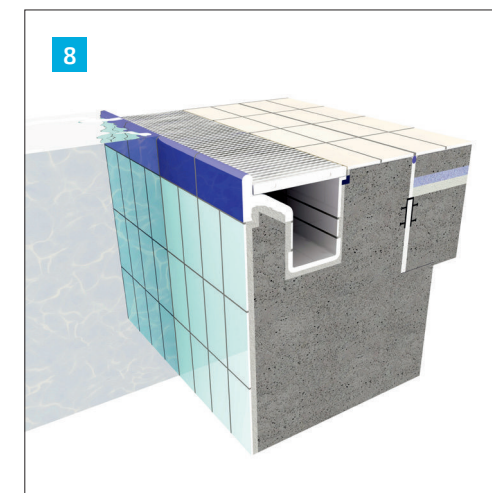

The »Berlin Channel«

Low drainage noise and more flexibility:

The Berlin Channel consists of an inclined gutter stone, which also serves as a grate support and hand grip. The inclination of the gutter stone reduces the noise of the draining water. The height and depth of the gutter can also be flexibly designed.

SPECIAL-FORM

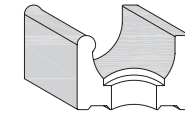
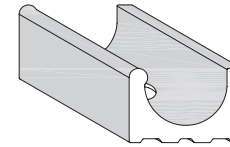
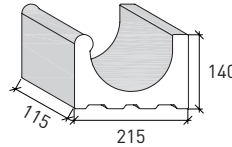
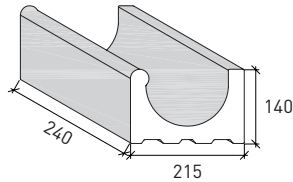

Colour glazed

5100 Overflow channel »Wiesbaden«
240 x 215 x 140 mm
510044 Overflow channel »Wiesbaden«
244 x 215 x 140 mm

5105 Overflow channel »Wiesbaden«, (1/2 size)
115 x 215 x 140 mm
510544 Overflow channel »Wiesbaden«, (1/2 size)
119 x 215 x 140 mm

5101 Overflow channel (outlet tile)
Ablauf 2½", Ø 109/83 mm
510144 Overflow channel (outlet tile)
Ablauf 2½", Ø 109/83 mm

9577 Overflow channel (1/2 outlet tile, left)
9578 Overflow channel (1/2 outlet tile, right)
115 x 215 x 140 mm
957744 Overflow channel (1/2 outlet tile, left)
957844 Overflow channel (1/2 outlet tile, right)
119 x 215 x 140 mm

	Price Group/ Piece	Price Group/ m ²	Price Group/ Piece	Price Group/ m ²	Price Group/ Piece	Price Group/ m ²	Price Group/ Piece	Price Group/ m ²
2220 2290	● 267		● 263		● 275		● 272 (Piece)	
3500	● 268		● 264		● 276		● 273 (Piece)	
2115 3505 3512 3740	○ 268		○ 264		○ 276		○ 273 (Piece)	
3513	● 268		● 264		● 276		● 273 (Piece)	
Pieces per m ² /r. m. incl. joints	4		8				4250	
Approx. weight in KG/1000 pcs	9000		4300		8500			
Pieces per bundle	1		2		1		2	
Pieces per pallet	72		144		72			

● = Standard material ○ = Upon request □ = Pallet discount For colours please see p. 58

Useful information

Collection »Special-Form« is also available in all colours of collections »Combi-Color I« and »Combi-Color II« upon request.

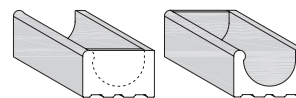
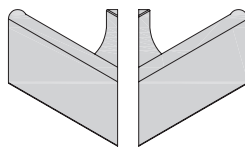
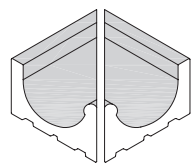

Colour glazed	510203/ 04 Overflow channel, internal corner 208 x 215 x 140 mm		956903/ 04 Overflow channel, external corner 238 x 215 x 140 mm		5103/ 04 End piece 240 x 215 x 140 mm	
	Price Group/ Piece	Price Group/ m ²	Price Group/ Piece	Price Group/ m ²	Price Group/ Piece	Price Group/ m ²
2220 2290	● 269 (Piece)		● 269 (Piece)		● 275 (Piece)	
3500	● 270 (Piece)		● 270 (Piece)		● 276 (Piece)	
2115 3505 3512 3740	○ 270 (Piece)		○ 270 (Piece)		○ 276 (Piece)	
3513	● 270 (Piece)		● 270 (Piece)		● 276 (Piece)	
<i>Pieces per m²/r. m. incl. joints</i>					7750	
<i>Approx. weight in KG/1000 pcs</i>	3960/3960		3500/3500		7750	
<i>Pieces per bundle</i>	1 pair		1 pair		1	
<i>Pieces per pallet</i>						

● = Standard material ○ = Upon request □ = Pallet discount For colours please see p. 58



Stadtbad Oderberger Straße, Berlin, Germany

SPECIAL-FORM

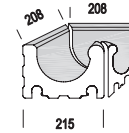
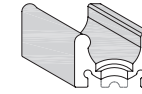
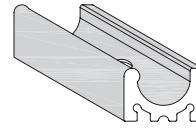
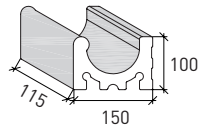
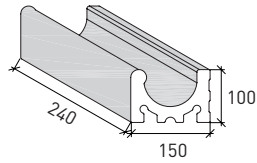

Colour glazed

	5110 Small overflow channel »Wiesbaden« 240 x 150 x 100 mm		5115 Small overflow channel, (1/2 size) 115 x 150 x 100 mm		5111 Small overflow channel (outlet tile) Ablauf 1 1/2", Ø 70/50 mm		511560 Small overflow channel (1/2 outlet tile, left)		511203/04 Overflow channel, internal corner 143 x 143 x 100 mm	
	511044 Small overflow channel »Wiesbaden« 244 x 150 x 100 mm	511544 Small overflow channel, (1/2 size) 119 x 150 x 100 mm	511144 Small overflow channel (outlet tile) Ablauf 1 1/2", Ø 70/50 mm	511561 Small overflow channel (1/2 outlet tile, right) 115 x 150 x 100 mm	511564 Small overflow channel (1/2 outlet tile, left)	511565 Small overflow channel (1/2 outlet tile, right) 119 x 150 x 100 mm				
	Price Group/ Piece	Price Group/ m ²	Price Group/ Piece	Price Group/ m ²	Price Group/ Piece	Price Group/ m ²	Price Group/ Piece	Price Group/ m ²	Price Group/ Piece	Price Group/ m ²
2220 2290	● 263		● 257		● 272		● 267 (Piece)		● 263 (Piece)	
3500	● 267		● 262		● 273		● 268 (Piece)		● 264 (Piece)	
2115 3505 3512 3740	○ 270		○ 263		○ 274		○ 269 (Piece)		○ 265 (Piece)	
3513	● 270		● 263		● 274		● 269 (Piece)		● 265 (Piece)	
Pieces per m ² /r. m. incl. joints	4		8		3950		1980		1125/1125	
Approx. weight in KG/1000 pcs	4150		1900		3950		1980		1125/1125	
Pieces per bundle	2		4		2		4		1 pair	
Pieces per pallet	120		240		120		4		1 pair	

● = Standard material ○ = Upon request □ = Pallet discount For colours please see p. 58

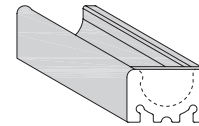
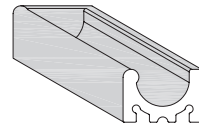
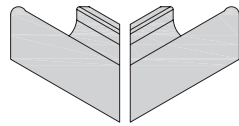

Colour
glazed

	511703/04 Overflow channel, external corner 238 x 150 x 100 mm		5113 End piece, left 240 x 150 x 100 mm		5114 End piece, right 240 x 150 x 100 mm	
	Price Group/ Piece	Price Group/ m ²	Price Group/ Piece	Price Group/ m ²	Price Group/ Piece	Price Group/ m ²
2220 2290	● 263 (Piece)		● 272		● 272	
3500	● 264 (Piece)		● 273		● 273	
2115 3505 3512 3740	○ 265 (Piece)		○ 274		○ 274	
3513	● 265 (Piece)		● 274		● 274	
Pieces per m ² /r. m. incl. joints						
Approx. weight in KG/1000 pcs	1300/1300		4350		4350	
Pieces per bundle	1 pair		2		2	
Pieces per pallet						

● = Standard material ○ = Upon request □ = Pallet discount For colours please see p. 58

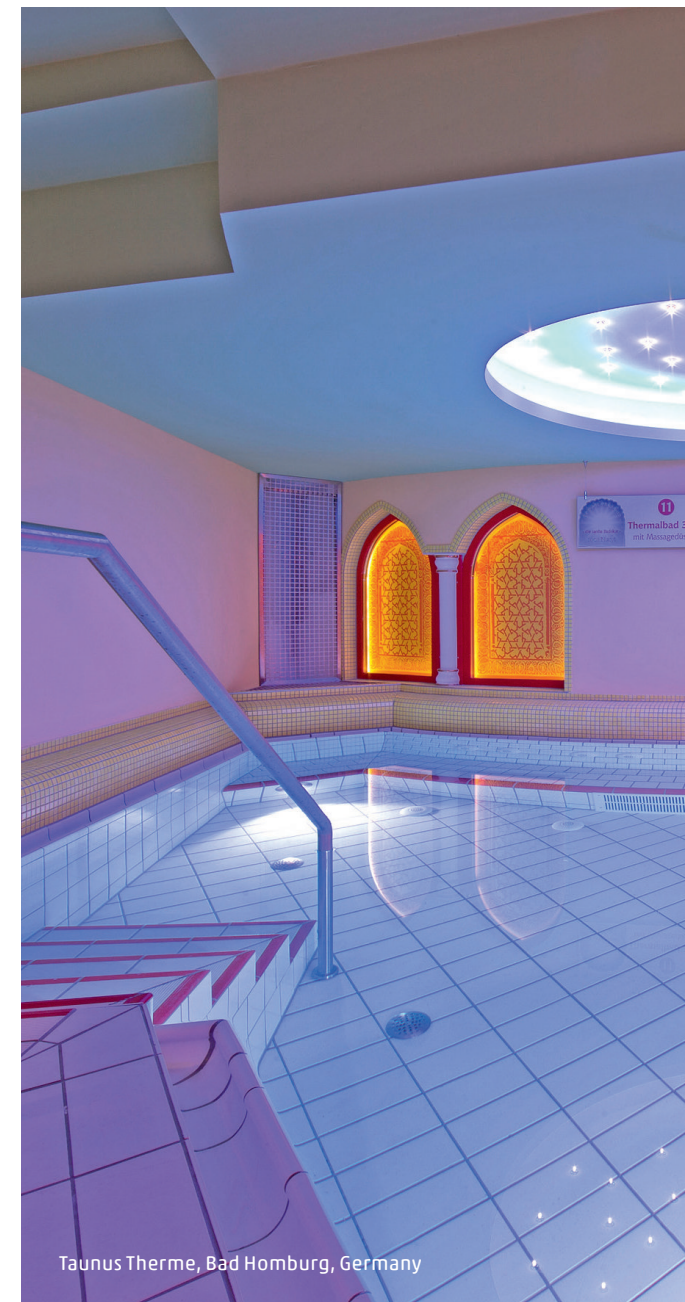

Taunus Therme, Bad Homburg, Germany

SPECIAL-FORM

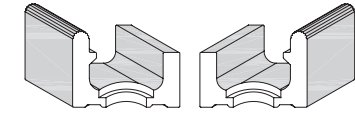
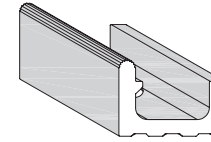
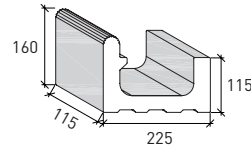
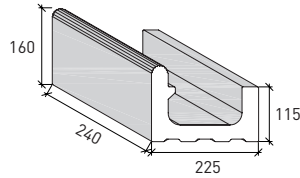

Colour
glazed

	5170 Overflow channel »Wiesbaden« with grooved edge 240 x 225 x 115/160 mm	5175 Overflow channel »Wiesbaden« with grooved edge (½ size) 115 x 225 x 115/160 mm	5171 Overflow channel »Wiesbaden« with grooved edge (outlet tile) Ablauf 2½", Ø 115/85 mm	517503 Overflow channel »Wiesbaden« (½ outlet tile, left)	517504 Overflow channel »Wiesbaden« (½ outlet tile, right) 115 x 225 x 115/160 mm	
	517044 Overflow channel »Wiesbaden« with grooved edge 244 x 225 x 115/160 mm	517544 Overflow channel »Wiesbaden« with grooved edge (½ size) 119 x 225 x 115/160 mm	517144 Overflow channel »Wiesbaden« with grooved edge (outlet tile) Outlet 2½", Ø 115/85 mm			
	Price Group/ Piece	Price Group/ m²	Price Group/ Piece	Price Group/ m²	Price Group/ Piece	Price Group/ m²
2220 2290	● 269		● 265		● 271 (Piece)	
3500	● 270		● 266		● 272 (Piece)	
2115 3505 3512 3513 3518 3521 3627 3740	○ 271		○ 267		○ 273 (Piece)	
Pieces per m²/r. m. incl. joints	4		8		8	
Approx. weight in KG/1000 pcs	8850		4300		4150	
Pieces per bundle	2		4		2	
Pieces per pallet	72		144		72	

● = Standard material ○ = Upon request □ = Pallet discount For colours please see p. 58

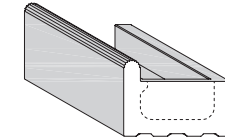
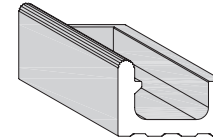
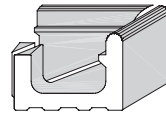
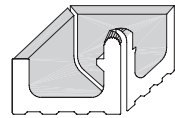

Colour glazed	517203/ 04 Overflow channel, internal corner 218 x 218 x 115/160 mm		957603/ 04 Overflow channel, external corner 233 x 225 x 115/160 mm		5173 End piece, left 240 x 225 x 115/160 mm		5174 End piece, right 240 x 225 x 115/160 mm	
	Price Group/ Piece	Price Group/ m ²	Price Group/ Piece	Price Group/ m ²	Price Group/ Piece	Price Group/ m ²	Price Group/ Piece	Price Group/ m ²
2220 2290	● 268 (Piece)		● 268 (Piece)		● 276		● 276	
3500	● 269 (Piece)		● 269 (Piece)		● 278		● 278	
2115 3505 3512 3513 3518 3521 3627 3740	○ 270 (Piece)		○ 270 (Piece)		○ 279		○ 279	
Pieces per m ² /r. m. incl. joints	3440/3440		4000/4000		10000		10000	
Approx. weight in KG/1000 pcs	3440/3440		4000/4000		10000		10000	
Pieces per bundle	1 pair		1 pair		1		1	
Pieces per pallet	1 pair		1 pair		1		1	

● = Standard material ○ = Upon request □ = Pallet discount For colours please see p. 58



SPECIAL-FORM

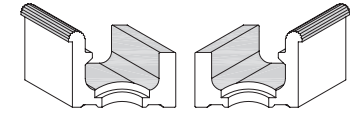
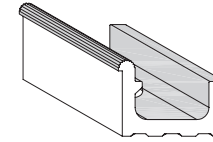
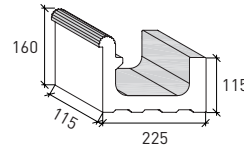
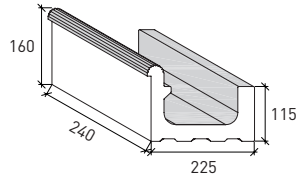

Colour glazed	5270 Overflow channel »Wiesbaden« with grooved edge and cut-out 240 x 225 x 115/160 mm		5275 Overflow channel »Wiesbaden« with grooved edge and cut-out (½ size) 115 x 225 x 115/160 mm		5271 Overflow channel »Wiesbaden« with grooved edge and cut-out (outlet tile) Outlet 2½", Ø 115/85 mm		527503 Overflow channel »Wiesbaden« (½ outlet tile, left)	
	527044 Overflow channel »Wiesbaden« with grooved edge and cut-out 244 x 225 x 115/160 mm		527544 Overflow channel »Wiesbaden« with grooved edge and cut-out (½ size) 119 x 225 x 115/160 mm		527144 Overflow channel »Wiesbaden« with grooved edge and cut-out (outlet tile) Outlet 2½", Ø 115/85 mm		527504 Overflow channel »Wiesbaden« (½ outlet tile, right) 115 x 225 x 115/160 mm	
	Price Group/ Piece	Price Group/ m²	Price Group/ Piece	Price Group/ m²	Price Group/ Piece	Price Group/ m²	Price Group/ Piece	Price Group/ m²
2220 2290	● 275		● 273		● 280		● 278 (Piece)	
3500	● 276		● 274		● 281		● 279 (Piece)	
2115 3505 3512 3513 3518 3521 3627 3740	○ 277		○ 275		○ 282		○ 280 (Piece)	
Pieces per m²/r. m. incl. joints	4		8		4		8	
Approx. weight in KG/1000 pcs	7300		3600		7100		4150	
Pieces per bundle	2		4		2		2	
Pieces per pallet	72		144		72			

● = Standard material ○ = Upon request □ = Pallet discount For colours please see p. 58

Useful information
Upon request we deliver tapered cut pieces for curved parts of swimming pool overflow channels. Price and delivery time upon request.

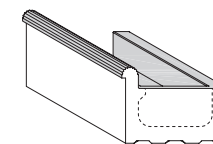
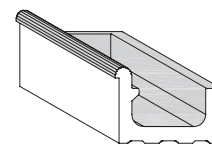
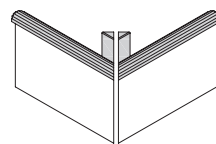
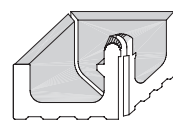

Colour glazed	527203/ Overflow channel, 04 internal corner 218 x 218 x 115/160 mm		527603/ Overflow channel, 04 external corner 238 x 225 x 115/160 mm		5273 End piece, left 240 x 225 x 115/160 mm		5274 End piece, right 240 x 225 x 115/160 mm	
	Price Group/ Piece	Price Group/ m ²	Price Group/ Piece	Price Group/ m ²	Price Group/ Piece	Price Group/ m ²	Price Group/ Piece	Price Group/ m ²
2220 2290	● 271 (Piece)		● 271 (Piece)		● 280		● 280	
3500	● 272 (Piece)		● 272 (Piece)		● 281		● 281	
2115 3505 3512 3513 3518 3521 3627 3740	○ 273 (Piece)		○ 273 (Piece)		○ 282		○ 282	
Pieces per m ² /r. m. incl. joints	3440/3440		3700/3700		9400		9400	
Approx. weight in KG/1000 pcs	1 pair		1 pair		1		1	
Pieces per bundle	1 pair		1 pair		1		1	
Pieces per pallet	1 pair		1 pair		1		1	

● = Standard material ○ = Upon request □ = Pallet discount For colours please see p. 58

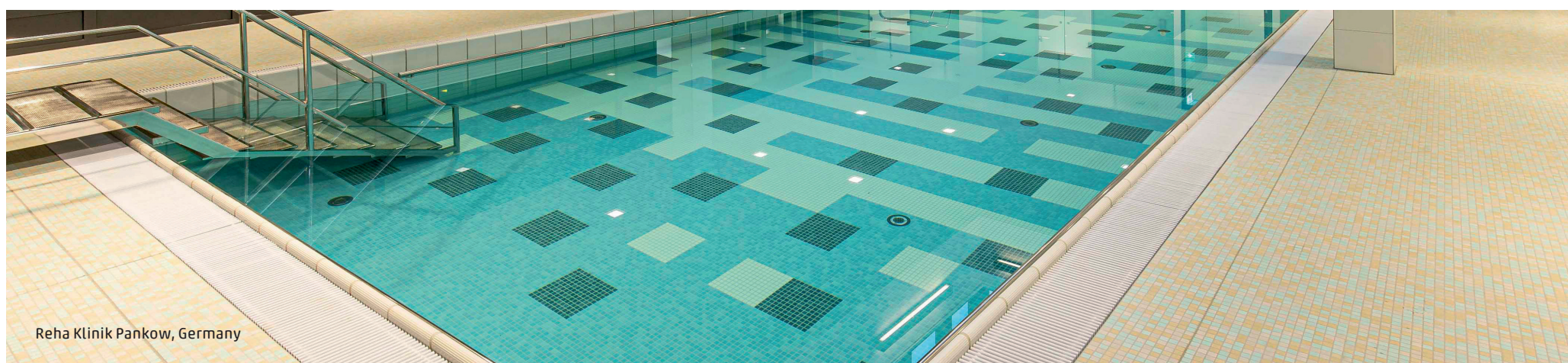

Reha Klinik Pankow, Germany

SPECIAL-FORM

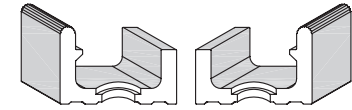
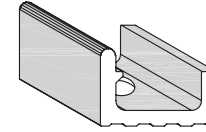
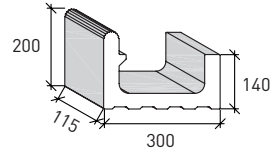
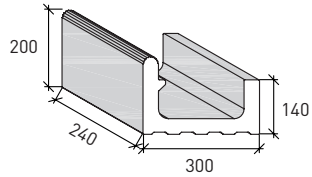

Colour glazed	5160 Large overflow channel »Wiesbaden« with grooved edge 240 x 300 x 140/200 mm		5165 Large overflow channel »Wiesbaden« with grooved edge (1/2 size) 115 x 300 x 140/200 mm		5161 Large overflow channel »Wiesbaden« with grooved edge (outlet tile) Outlet 2 1/2", Ø 115/85 mm		516560 Large overflow channel »Wiesbaden« (1/2 outlet tile, left)	
	516044 Large overflow channel »Wiesbaden« with grooved edge 244 x 300 x 140/200 mm		516544 Large overflow channel »Wiesbaden« with grooved edge (1/2 size) 119 x 300 x 140/200 mm		516144 Large overflow channel »Wiesbaden« with grooved edge (outlet tile) Outlet 2 1/2", Ø 115/85 mm		516561 Large overflow channel »Wiesbaden« (1/2 outlet tile, right) 115 x 300 x 140/200 mm	
	Price Group/ Piece	Price Group/ m ²	Price Group/ Piece	Price Group/ m ²	Price Group/ Piece	Price Group/ m ²	Price Group/ Piece	Price Group/ m ²
2220 2290	● 278		● 275		● 281		● 279 (Piece)	
3500	● 279		● 276		● 282		● 280 (Piece)	
2115 3505 3512 3513 3518 3521 3627 3740	○ 280		○ 278		○ 283		○ 281 (Piece)	
Pieces per m ² /r. m. incl. joints	4		8		11800		6200	
Approx. weight in KG/1000 pcs	12000		5630		11800		6200	
Pieces per bundle	2		2		2		2	
Pieces per pallet	48		96		48		48	

● = Standard material ○ = Upon request □ = Pallet discount For colours please see p. 58

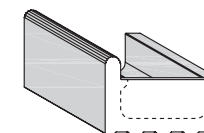
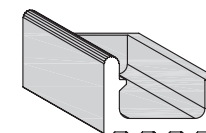
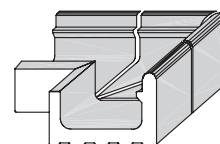
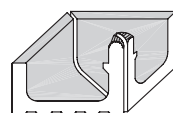
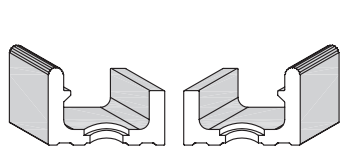

Colour glazed	516564 Large overflow channel »Wiesbaden« (1/2 outlet tile, left)		516203/04 Large overflow channel, internal corner		956701-04 Large overflow channel, external corner		5163 End piece, left		5164 End piece, right	
	Price Group/ Piece	Price Group/ m ²	Price Group/ Piece	Price Group/ m ²	Price Group/ Piece	Price Group/ m ²	Price Group/ Piece	Price Group/ m ²	Price Group/ Piece	Price Group/ m ²
2220 2290	● 279 (Piece)		● 275 (Piece)		● 275 (Piece)		● 281		● 281	
3500	● 280 (Piece)		● 276 (Piece)		● 276 (Piece)		● 282		● 282	
2115 3505 3512 3513 3518 3521 3627 3740	○ 281 (Piece)		○ 277 (Piece)		○ 277 (Piece)		○ 283		○ 283	
Pieces per m ² /r. m. incl. joints	6200		7050/7050		31500		13000		13000	
Approx. weight in KG/1000 pcs	2		1 pair		1 set		1		1	
Pieces per bundle	48		50		50					
Pieces per pallet										

● = Standard material ○ = Upon request □ = Pallet discount For colours please see p. 58

SPECIAL-FORM

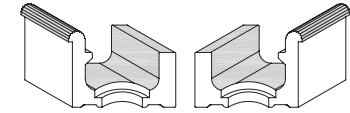
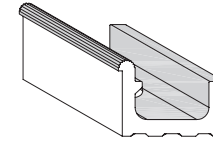
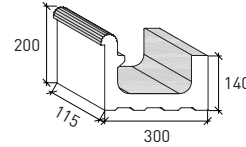
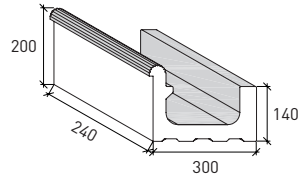

Colour
glazed

	5260	Large Overflow channel »Wiesbaden« with grooved edge and cut-out 240 x 300 x 140/200 mm	5265	Large Overflow channel »Wiesbaden« with grooved edge and cut-out (1/2 size) 115 x 300 x 140/200 mm	5261	Large Overflow channel »Wiesbaden« with grooved edge and cut-out (outlet tile) 240 x 300 x 140/200 mm Outlet 2 1/2", Ø 115/85 mm	526560	Large Overflow channel »Wiesbaden« (1/2 outlet tile, left)	526561	Large Overflow channel »Wiesbaden« (1/2 outlet tile, right) 115 x 300 x 140/200 mm
	526044	Large Overflow channel »Wiesbaden« with grooved edge and cut-out 244 x 300 x 140/200 mm	526544	Large Overflow channel »Wiesbaden« with grooved edge and cut-out (1/2 size) 119 x 300 x 140/200 mm	526144	Large Overflow channel »Wiesbaden« with grooved edge and cut-out (outlet tile) 244 x 300 x 140/200 mm Outlet 2 1/2", Ø 115/85 mm				
	Price Group/ Piece	Price Group/ m ²	Price Group/ Piece	Price Group/ m ²	Price Group/ Piece	Price Group/ m ²	Price Group/ Piece	Price Group/ m ²	Price Group/ Piece	Price Group/ m ²
2220 2290	● 282		● 281		● 284		● 284		● 284	
3500	● 282		● 281		● 284		● 284		● 284	
2115 3505 3512 3513 3518 3521 3627 3740	● 283		● 282		● 284		● 284		● 284	
Pieces per m ² /r. m. incl. joints		4		8						
Approx. weight in KG/1000 pcs		12000		6000		11800				5900
Pieces per bundle		1		2		1				2
Pieces per pallet		48		96		48				

● = Standard material ○ = Upon request □ = Pallet discount For colours please see p. 58

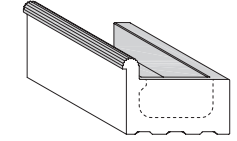
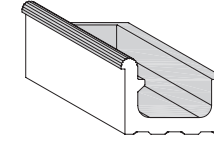
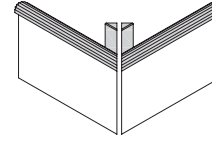
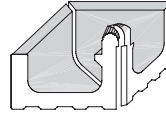
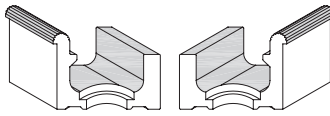

Colour glazed

Colour	526564 Large Overflow channel »Wiesbaden« (½ outlet tile, left)		526203/04 Large overflow channel, internal corner		526701-04 Large overflow channel, external corner		5263 End piece, left		5264 End piece, right	
	Price Group/ Piece	Price Group/ m ²	Price Group/ Piece	Price Group/ m ²	Price Group/ Piece	Price Group/ m ²	Price Group/ Piece	Price Group/ m ²	Price Group/ Piece	Price Group/ m ²
2220 2290	● 284		● 280 (Piece)		● 268 (Piece)		● 284		● 284	
3500	● 284		● 280 (Piece)		● 268 (Piece)		● 284		● 284	
2115 3505 3512 3513 3518 3521 3627 3740	● 284		● 281 (Piece)		● 269 (Piece)		● 284		● 284	
Pieces per m ² /r. m. incl. joints							13000		13000	
Approx. weight in KG/1000 pcs	5900		4750/4750		31500		13000		13000	
Pieces per bundle	2		1 pair		1 set		1		1	
Pieces per pallet										

● = Standard material ○ = Upon request □ = Pallet discount For colours please see p. 58

SPECIAL-FORM

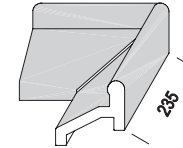
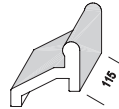
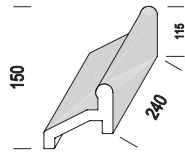

Colour	5180 Overflow channel »Berlin« 240 x 160 x 150 mm		5185 Overflow channel »Berlin« (1/2 size) 115 x 160 x 150 mm		518903/ External corner 04 235 x 155 x 150 mm		518203/ Internal mitre 04 155 x 155 x 150 mm		
		Price Group/ Piece	Price Group/ m ²	Price Group/ Piece	Price Group/ m ²	Price Group/ Piece	Price Group/ m ²	Price Group/ Piece	Price Group/ m ²
glazed	2220 2290	● 271		● 269		● 274 (Piece)		● 274 (Piece)	
	3500	● 272		● 270		● 275 (Piece)		● 275 (Piece)	
	2115 3505 3512 3513	○ 273		○ 271		○ 275 (Piece)		○ 275 (Piece)	
Pieces per m ² /r. m. incl. joints		4		8					
Approx. weight in KG/1000 pcs		3700		1775		2630		766	
Pieces per bundle		2		4		2		1	
Pieces per pallet		142		284					

● = Standard material ○ = Upon request □ = Pallet discount For colours please see p. 58

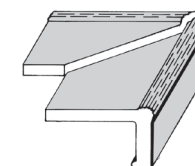
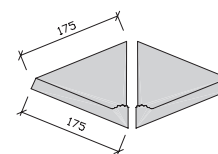
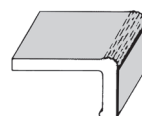
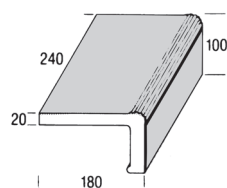

Colour	5400 Edging tile* 240/100 x 180 x 20 mm		5405 1/2 Edging tile* 115/100 x 180 x 20 mm		540201/ Internal mitre angle 02 175 x 175 x 20 mm		540303/ External corner* 04 235/100 x 180 x 20 mm		
		Price Group/ Piece	Price Group/ m ²	Price Group/ Piece	Price Group/ m ²	Price Group/ Piece	Price Group/ m ²	Price Group/ Piece	Price Group/ m ²
unglazed 1030	●	255		●	252	●	249 (Piece)	●	255 (Piece)
glazed 2220 2290	●	265		●	258			●	265 (Piece)
3500	●	266		●	259			●	266 (Piece)
2115 3505 3512 3513	○	266		○	259			○	266 (Piece)
Pieces per m ² /r. m. incl. joints		4			8				
Approx. weight in KG/1000 pcs		2790			1580		1600		
Pieces per bundle		4			8		4		2
Pieces per pallet		180			360				

● = Standard material ○ = Upon request □ = Pallet discount For colours please see p. 58

* In case of glazed colour only the vertical surface will be glazed.

SPECIAL-FORM

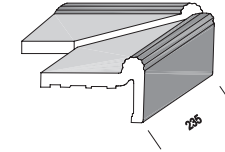
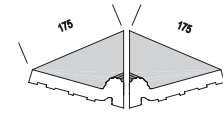
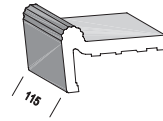
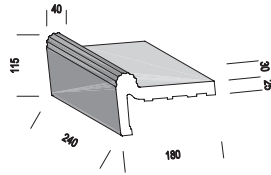

Colour	5450 Edging tile*		5455 ½ Edging tile*		545201/02 Internal mitre angle		545303/04 External corner*		
	240/115 x 180 x 25 mm		115/115 x 180 x 25 mm		175 x 175 x 25 mm		235/115 x 180 x 25 mm		
		Price Group/ Piece	Price Group/ m ²	Price Group/ Piece	Price Group/ m ²	Price Group/ Piece	Price Group/ m ²	Price Group/ Piece	Price Group/ m ²
unglazed	1030	○ 262		○ 256		● 251 (Piece)		○ 261 (Piece)	
glazed*	2220	● 271		● 267		● 253 (Piece)		● 271 (Piece)	
	2290	○ 271		○ 267		○ 253 (Piece)		○ 271 (Piece)	
	3500	● 272		● 268		● 255 (Piece)		● 272 (Piece)	
	2115 3505 3512 3513	○ 272		○ 268		○ 255 (Piece)		○ 272 (Piece)	
Pieces per m ² /r.m. incl. joints		4		8		1630		2	
Approx. weight in KG/1000 pcs		3200		1600		1630			
Pieces per bundle		3		6		4			
Pieces per pallet		180		360					

● = Standard material ○ = Upon request □ = Pallet discount For colours please see p. 58

* In case of glazed colour only the vertical surface and the bulb are glazed. Upon request, the edging tiles are also available in unglazed finish. Upon request, the stepping surface is also available in slip-resistant glazing finish.

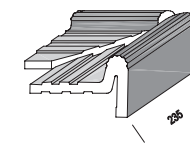
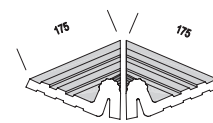
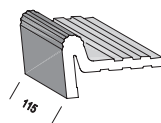
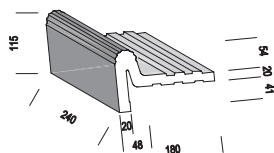

Colour	5460 Edging tile*		5465 1/2 Edging tile*		546201/02 Internal mitre angle		546303/04 External corner**		
	240/115 x 180 x 25 mm		115/115 x 180 x 25 mm		175 x 175 x 25 mm		235/115 x 180 x 25 mm		
		Price Group/ Piece	Price Group/ m ²	Price Group/ Piece	Price Group/ m ²	Price Group/ Piece	Price Group/ m ²	Price Group/ Piece	Price Group/ m ²
unglazed	1030	○ 262		○ 256		○ 251 (Piece)		○ 261 (Piece)	
glazed*	2220	● 269		● 266		● 253 (Piece)		● 271 (Piece)	
	2290	○ 269		○ 266		○ 253 (Piece)		○ 271 (Piece)	
	3500	● 270		● 267		● 255 (Piece)		● 272 (Piece)	
	2115 3505 3512 3513	○ 270		○ 267		○ 255 (Piece)		○ 272 (Piece)	
Pieces per m ² /r.m. incl. joints		4		8					
Approx. weight in KG/1000 pcs		3250		1687		1650			
Pieces per bundle		2		4		2		2	
Pieces per pallet		180		360					

● = Standard material ○ = Upon request □ = Pallet discount For colours please see p. 58

* In case of glazed colour only the vertical surface and the bulb are glazed.

SPECIAL-FORM



Parkbad, Hamburg-Volksdorf, Germany (bs2architekten)

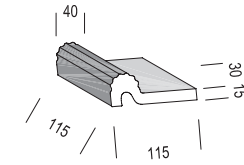
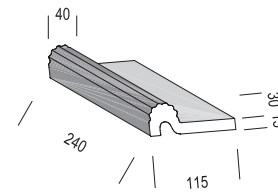

Colour

		5750	Edging tile* 240 x 115 x 45/15 mm	5755	½ Edging tile* 115 x 115 x 45/15 mm	
		575044	Edging tile 244 x 115 x 45/15 mm	575544	½ Edging tile 119 x 115 x 45/15 mm	
			Price Group/ Piece	Price Group/ m ²	Price Group/ Piece	Price Group/ m ²
unglazed	1030	●	249		●	247
glazed	2220 2290	●	251		●	248
	2115 3500	●	252		●	249
	3505 3512					
	3513					
Pieces per m ² /r. m. incl. joints			4			8
Approx. weight in KG/1000 pcs			1200			600
Pieces per bundle			10			20
Pieces per pallet			600			1200

● = Standard material ○ = Upon request □ = Pallet discount For colours please see p. 58

* In case of glazed colour only the vertical surface and the bulb are glazed.

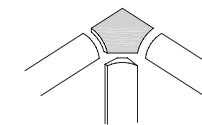
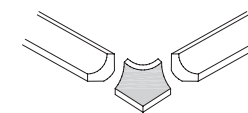
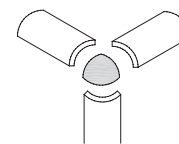
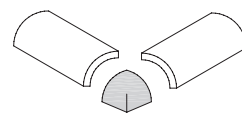
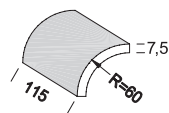
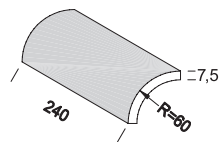

Colour	9412 Radial tile R 60 x 240 x 7,5 mm		9415 1/2 Radial tile R 60 x 115 x 7,5 mm		941264 Convex bead with 2 connec- tions for radial tile 9412		941269 Convex bead with 3 connec- tions for radial tile 9412		941257 Convex cover for radial tile 9412 and cover 4100		941258 Internal mitre angle for radial tile 9412 and cover 4100	
	Price Group/ Piece	Price Group/ m ²	Price Group/ Piece	Price Group/ m ²	Price Group/ Piece	Price Group/ m ²	Price Group/ Piece	Price Group/ m ²	Price Group/ Piece	Price Group/ m ²	Price Group/ Piece	Price Group/ m ²
unglazed	1030	● 237	● 235		● 249		● 249		● 252		● 252	
glazed	2220 2290	● 240	● 236		● 250		● 250		● 253		● 253	
	2115 3500	● 242	● 238		● 252		● 252		● 255		● 255	
	3505 3512 3513											
	22106	● 242	● 238									
Pieces per m ² /r. m. incl. joints	4		8		190		120		340		100	
Approx. weight in KG/1000 pcs	730		360		190		120		340		100	
Pieces per bundle	33		66		190		120		340		100	
Pieces per pallet	1980		3960		190		120		340		100	

● = Standard material ○ = Upon request □ = Pallet discount For colours please see p. 58

Useful information

The radial tiles are also available in colours of collections »Combi-Color I« and »Combi-Color II« upon request, please ask for prices and delivery time.

SPECIAL-FORM

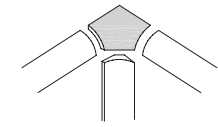
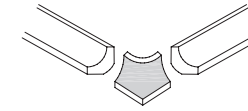
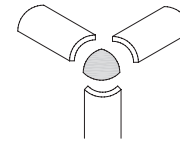
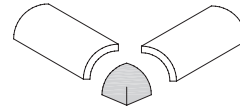
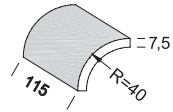
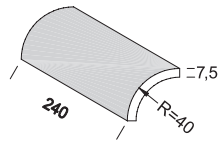

Colour		9450 Radial tile R 40 x 240 x 7,5 mm		9455 1/2 Radial tile R 40 x 115 x 7,5 mm		945064 Convex bead with 2 connections for radial tile 9450		945061 Convex bead with 3 connections for radial tile 9450		945067 Convex cover for radial tile 9450 and cover 4100		945068 Internal mitre angle for radial tile 9450 and cover 4100	
		Price Group/ Piece	Price Group/ m ²	Price Group/ Piece	Price Group/ m ²	Price Group/ Piece	Price Group/ m ²	Price Group/ Piece	Price Group/ m ²	Price Group/ Piece	Price Group/ m ²	Price Group/ Piece	Price Group/ m ²
unglazed	1030	● 230		● 227		● 245		● 245		● 246		● 250	
glazed	2220 2290	● 231		● 228		● 246		● 246		● 247		● 251	
	22106	● 234		● 232		● 247		● 247		● 248		● 252	
	2115 3500	● 234		● 232		● 247		● 247		● 249		● 254	
	3512 3513												
	3518 3521												
	3627 35136												
	35956												
<i>Pieces per m²/r. m. incl. joints</i>		4		8		60		27		100		100	
<i>Approx. weight in KG/1000 pcs</i>		300		105		60		27		100		100	
<i>Pieces per bundle</i>		50		100		60		27		100		100	
<i>Pieces per pallet</i>		3000		6000		60		27		100		100	

● = Standard material ○ = Upon request □ = Pallet discount For colours please see p. 58

Useful information

The radial tiles are also available in colours of collections »Combi-Color I« and »Combi-Color II« upon request, please ask for prices and delivery time.

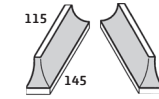
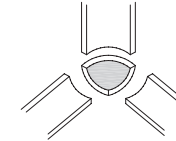
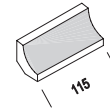
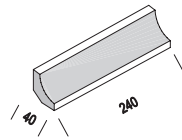
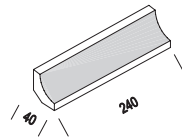

Colour		4100 Cove 240 x 40 x 40 x 7,5 mm	4101 Cove, stop end 240 x 40 x 40 x 7,5 mm	4200 ½ Cove 115 x 40 x 40 x 7,5 mm	4102 Cove, internal angle 40 x 40 x 40 mm	4203 Cove, external angle, left	410044 Cove 244 x 40 x 40 x 7,5 mm	410144 Cove, stop end 244 x 40 x 40 x 7,5 mm	420044 ½ Cove 119 x 40 x 40 x 7,5 mm	4204 Cove, external angle, right	
		Price Group/ Piece	Price Group/ m ²	Price Group/ Piece	Price Group/ m ²	Price Group/ Piece	Price Group/ m ²	Price Group/ Piece	Price Group/ m ²	Price Group/ Piece	Price Group/ m ²
unglazed	1030	● 226		● 229		● 236		● 225		● 236 (Piece)	
glazed	2220 2290	● 229		● 232		● 236		● 227		● 236 (Piece)	
	3500	● 231		● 234		● 238		● 229		● 238 (Piece)	
<i>Pieces per m²/r. m. incl. joints</i>			4						8		
<i>Approx. weight in KG/1000 pcs</i>			344		344				172		137
<i>Pieces per bundle</i>			48		48				96		32
<i>Pieces per pallet</i>			3456		3456				6912		108

● = Standard material ○ = Upon request □ = Pallet discount For colours please see p. 58



Hallenbad Schwarmstedt, Germany
Architekt PGH Hildesheim GmbH

SPECIAL-FORM

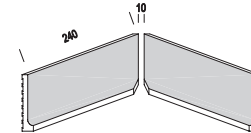
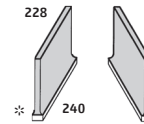
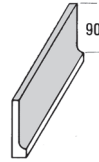

Colour		4000 Cove skirting (square top) 240 x 100 x 10/20 mm 400044 Cove skirting (square top) 244 x 100 x 10/20 mm		4001 Cove skirting, external angle, left 4002 Cove skirting, external angle, right 228/240 x 100 mm		400503 Internal mitre, left 400504 Internal mitre, right 240 x 100 x 10/20 mm 400543 Internal mitre, left 400544 Internal mitre, right 244 x 100 x 10/20 mm	
		Price Group/ Piece	Price Group/ m ²	Price Group/ Piece	Price Group/ m ²	Price Group/ Piece	Price Group/ m ²
unglazed	1030	● 227		○ 236 (Piece)		● 236 (Piece)	
glazed	2220 2290	● 229		● 236 (Piece)		● 237 (Piece)	
<i>Pieces per m²/r. m. incl. joints</i>		4				4	
<i>Approx. weight in KG/1000 pcs</i>		580		280		493	
<i>Pieces per bundle</i>		20		20		20	
<i>Pieces per pallet</i>		1400		1296		1500	

● = Standard material ○ = Upon request □ = Pallet discount For colours please see p. 58

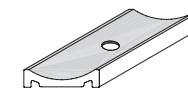
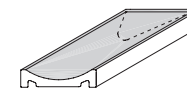
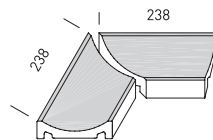
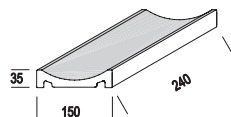
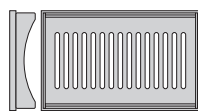

Colour / Design

		0748	4420	442044	442303/04	4424	4429	442944	
		Stainless steel drainage grille for flat channel with plastic substructure 246 x 155 x 40 mm	Shallow channel 240 x 150 x 35 mm	Shallow channel 244 x 150 x 35 mm	Internal corner 238 x 150 x 35 mm	End piece 240 x 150 x 35 mm	Shallow channel with outlet 1½", Ø 70/50 mm, 240 x 150 x 35 mm	Shallow channel with outlet 1½", Ø 70/50 mm, 244 x 150 x 35 mm	
		Price Group/ Piece	Price Group/ m ²	Price Group/ Piece	Price Group/ m ²	Price Group/ Piece	Price Group/ m ²	Price Group/ Piece	Price Group/ m ²
Stainless steel		Price upon request							
unglazed	1030			● 237	● 248 (Piece)	● 259	● 254		
glazed	22106			● 245	● 248 (Piece)	● 263	● 257		
Pieces per m ² /r. m. incl. joints			4						
Approx. weight in KG/1000 pcs		1446	1670		1130/1130	1700	1570		
Pieces per bundle		1	8		8	8	8		
Pieces per pallet			400			400	400		

● = Standard material ○ = Upon request □ = Pallet discount For colours please see p. 58

SPECIAL-FORM

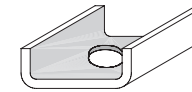
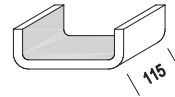
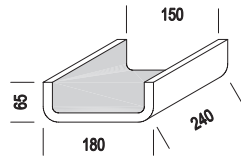

Colour	4900 Channel tile 240 x 180 x 65 x 150 mm		4905 ½ Channel tile 115 x 50 x 40 mm		4901 Channel tile with outlet Outlet 2½", Ø 115/85 mm 240 x 180 x 65 x 150 mm		490303/04 Internal mitre channel tile 309/65 x 180 x 65 mm	
	490044 Channel tile 244 x 180 x 65 x 150 mm		490544 ½ Channel tile 119 x 50 x 40 mm		490144 Channel tile with outlet Outlet 2½", Ø 115/85 mm 244 x 180 x 65 x 150 mm			
	Price Group/ Piece	Price Group/ m²	Price Group/ Piece	Price Group/ m²	Price Group/ Piece	Price Group/ m²	Price Group/ Piece	Price Group/ m²
unglazed	1030							
glazed	2220 2290	● 249	● 248		● 268		● 253 (Piece)	
Pieces per m²/r.m. incl. joints	4		8		4		1475/1475	
Approx. weight in KG/1000 pcs	2162		585		2100			
Pieces per bundle	4		8		4			
Pieces per pallet	192		362		192			

● = Standard material ○ = Upon request □ = Pallet discount For colours please see p. 58

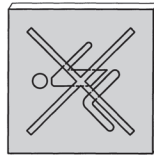

1,60 m

1,60 m

Colour	96097 Pictogram, grey cream 240 x 240 x 10 mm		4509 Racing number tile, grey cream 240 x 240 x 10 mm		915408 Lettering tile, grey cream Size 1100 up to max. 5 letters or numbers in anthracite or Atlantic blue		Lettering tile, white antislip		915410 Lettering tile with water-jet cutting or digital printing, grey cream or white antislip Size 1100 up to max. 5 letters or numbers in anthracite or Atlantic blue	
	Price Group/ Piece	Price Group/ m ²	Price Group/ Piece	Price Group/ m ²	Price Group/ Piece	Price Group/ m ²	Price Group/ Piece	Price Group/ m ²	Price Group/ Piece	Price Group/ m ²
unglazed	1030									
glazed	2220 2290									
	3513	○ 281	○ 266		● 280		● 281			
	3740		○ 266		● 280		● 281			
Pieces per m ² /r.m. incl. joints										
Approx. weight in KG/1000 pcs		1310		1310			600			600
Pieces per bundle										
Pieces per pallet										

Prices upon request

● = Standard material ○ = Upon request □ = Pallet discount For colours please see p. 58

SPECIAL-FORM



Waerket Thyboron Vandkulturhaus, Denmark

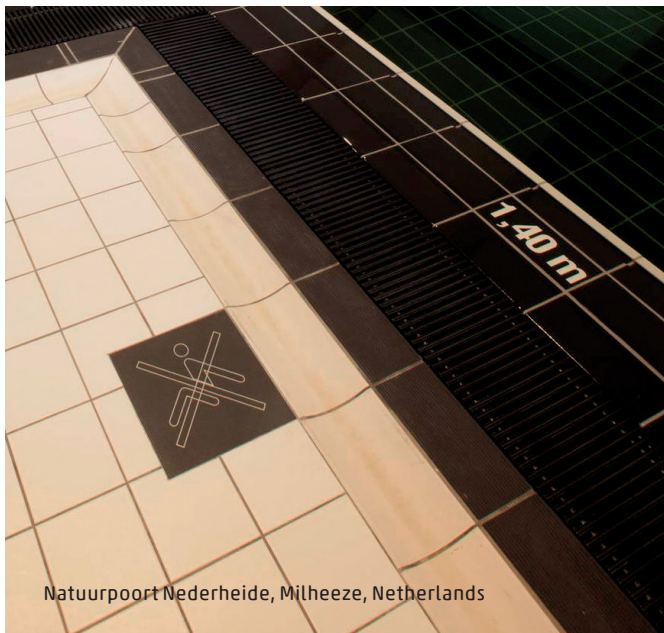

Natuurpoort Nederheide, Milheeze, Netherlands

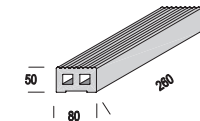
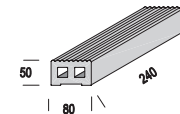

Colour

5563 Ladder step tile
240 x 80 x 50 mm
556344 Ladder step tile
244 x 80 x 50 mm

5565 Ladder step tile
260 x 80 x 50 mm

		Price Group/ Piece	Price Group/ m ²	Price Group/ Piece	Price Group/ m ²
unglazed	1030	● 250		● 250	
glazed	2220 2290	○ 261		○ 264	
	3513 3740	○ 263		○ 265	
<i>Pieces per m²/r. m. incl. joints</i>			4		3,7
<i>Approx. weight in KG/1000 pcs</i>			1780		2100
<i>Pieces per bundle</i>			8		8
<i>Pieces per pallet</i>			480		384

● = Standard material ○ = Upon request □ = Pallet discount For colours please see p. 58

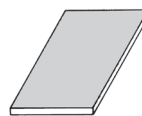
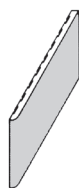

Colour

1105 Rounded on short side
 1106 Rounded on long side
 1107 Rounded on corner, left
 1108 Rounded on corner, right
 240 x 115 x 10 mm

110544 Rounded on short side
 110644 Rounded on long side
 110744 Rounded on corner, left
 110844 Rounded on corner, right
 244 x 115 x 10 mm

1150 Extruded split tile
 1151 Finished edges short side
 1152 Finished edges long side
 1153 Finished edges corner, left
 1154 Finished edges corner, right
 240 x 150 x 10 mm

115044 Extruded split tile
 115144 Finished edges short side
 115244 Finished edges long side
 115344 Finished edges corner, left
 115444 Finished edges corner, right
 244 x 150 x 10 mm

1156 Rounded on long side
 1155 Rounded on short side
 240 x 150 x 10 mm

115644 Rounded on long side
 115544 Rounded on short side
 244 x 150 x 10 mm

1157 Corner, left
1158 Corner, right
 240 x 150 x 10 mm

115744 Corner, left
115844 Corner, right
 244 x 150 x 10 mm

		Price Group/ Piece	Price Group/ m ²	Price Group/ Piece	Price Group/ m ²	Price Group/ Piece	Price Group/ m ²	Price Group/ Piece	Price Group/ m ²
unglazed	1030	● 224		● 223		● 229		● 234	
glazed	2220 2290	● 225		● 225		● 230		● 235	
	2115 3500 3513	● 227		● 230		● 234		● 238	
	3512 3518 3521 3627	○ 227							
	22106	● 227		● 230		● 234		● 240	
	35136 35956	● 230		○ 230		● 235		● 240	
Pieces per m ² /r. m. incl. joints		8		26		4		1	
Approx. weight in KG/1000 pcs		600		847		847		847	
Pieces per bundle		30		24		24			
Pieces per pallet		1800		1560		1560			

● = Standard material ○ = Upon request □ = Pallet discount For colours please see p. 58



Hallenbad Schwarmstedt, Germany
Architekt PGH Hildesheim GmbH

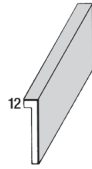

Colour	9039 Angle tile 240 x 115/25 x 10 mm		903962 1/2 Angle tile 115 x 115/25 x 10 mm		4885 Angle tile, angled 107° 240 x 115/25 x 10 mm		488562 1/2 Angle tile, angled 107° 115 x 115/25 x 10 mm	
	Price Group/ Piece	Price Group/ m ²	Price Group/ Piece	Price Group/ m ²	Price Group/ Piece	Price Group/ m ²	Price Group/ Piece	Price Group/ m ²
unglazed 1030	● 232		● 228		● 236		● 234	
glazed 2220 2290	● 233		● 230		● 238		● 235	
2115 3500	● 235		● 234		● 241		● 237	
3513 3512								
3518 3521								
3627								
22106 35136	○ 235		○ 234		○ 241		○ 237	
Pieces per m ² /r. m. incl. joints	4		8		4		8	
Approx. weight in KG/1000 pcs	850		475		850		475	
Pieces per bundle	16		32		16		32	
Pieces per pallet	1120		2240		960		1920	

● = Standard material ○ = Upon request □ = Pallet discount For colours please see p. 58

SPECIAL-FORM

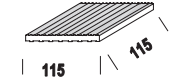
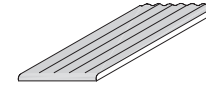
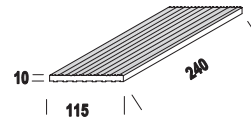
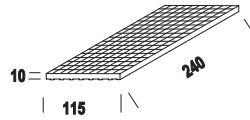

Colour		3170 Check-stud tile (flat diamond point, unglazed C/R12V6) 240 x 115 x 10 mm		3130 Grooved tile (C/R11V8)		3135 Rounded on short side 240 x 115 x 10 mm		3230 1/2 Grooved tile 115 x 115 x 10 mm	
317044 Check-stud tile (flat diamond point, unglazed C/R12V6) 244 x 115 x 10 mm		313044 Grooved tile (C/R11V8)		313144 Short side 244 x 115 x 10 mm		313544 Rounded on short side 244 x 115 x 10 mm		323044 1/2 Grooved tile 119 x 115 x 10 mm	
		Price Group/ Piece	Price Group/ m ²	Price Group/ Piece	Price Group/ m ²	Price Group/ Piece	Price Group/ m ²	Price Group/ Piece	Price Group/ m ²
unglazed	1030	● 225		● 219		● 231		● 218	
glazed	2220 2290	● 227							
	3400 3500 3513 3740	● 229							
	2115 3505 3512	○ 229							
	22106	○ 229		● 224		● 234		● 223	
	35136 35956 37406	○ 229		● 226		○ 235		○ 224	
<i>Pieces per m²/r. m. incl. joints</i>		33		33		4		66	
<i>Approx. weight in KG/1000 pcs</i>		600		570		521		285	
<i>Pieces per bundle</i>		25		25		25		50	
<i>Pieces per pallet</i>		1800		1800		1800		3600	

● = Standard material ○ = Upon request □ = Pallet discount For colours please see p. 58

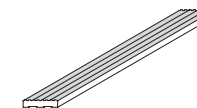
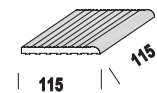
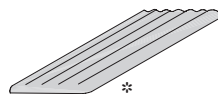
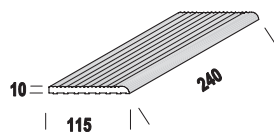

Colour	3136 Grooved stair tile, rounded on long side 240 x 115 x 10 mm		3137 Corner, left* 3138 Corner, right 313744 Corner, left* 313844 Corner, right		3236 ½ Grooved stair tile, rounded on long side 115 x 115 x 10 mm 323644 ½ Grooved stair tile, rounded on long side 119 x 115 x 10 mm		3120 Grooved fillet tile 240 x 56 x 10 mm 312044 Grooved fillet tile 244 x 56 x 10 mm		
		Price Group/ Piece	Price Group/ m ²	Price Group/ Piece	Price Group/ m ²	Price Group/ Piece	Price Group/ m ²	Price Group/ Piece	Price Group/ m ²
unglazed	1030	● 222		● 234		● 221			
glazed	22106	● 230		● 238		● 228			
	35956 35136 37406	○ 235		○ 240		○ 234		● 234	
Pieces per m ² /r.m. incl. joints			4			8			4
Approx. weight in KG/1000 pcs			521		600		250		400
Pieces per bundle			25		25		60		44
Pieces per pallet			1800		1800		3600		

● = Standard material ○ = Upon request □ = Pallet discount For colours please see p. 58



Lippumäki uimahalli, Kuopio, Finland
(Arkkitehti Sillman Oy Architekturbüro)

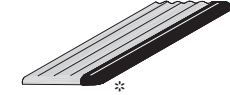
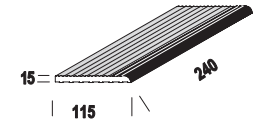
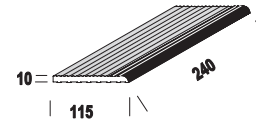

Colour glazed

	5620	562015	5627	5628	562744	562844
	Grooved stair tile, grey cream With safety line in anthracite or atlantic blue (antislip) 240 x 115 x 10 mm	Grooved stair tile, grey cream With safety line in anthracite or atlantic blue (antislip) 240 x 115 x 15 mm	Corner, left*	Corner, right	Corner, left*	Corner, right
	562044 Grooved stair tile, grey cream With safety line in 307406 or 305136 (see page 58) 244 x 115 x 10 mm	562045 Grooved stair tile, grey cream With safety line in 307406 or 305136 (see page 58) 244 x 115 x 15 mm				
	Price Group/ Piece	Price Group/ m ²	Price Group/ Piece	Price Group/ m ²	Price Group/ Piece	Price Group/ m ²
35136	● 231		● 232		● 240	
37406	● 232		● 233		● 240	
Pieces per m ² /r.m. incl. joints	4		4			
Approx. weight in KG/1000 pcs	538		790		538	
Pieces per bundle	30		20		30	
Pieces per pallet	1800		1200			

● = Standard material ○ = Upon request □ = Pallet discount For colours please see p. 58

SPECIAL-FORM

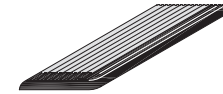
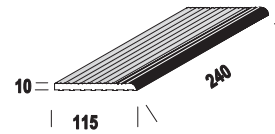
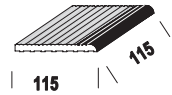

Colour glazed

562560 ½ Grooved stair tile, antislip glazed, white matte
With safety line in anthracite or atlantic blue (antislip)
115 x 115 x 10 mm

562564 ½ Grooved stair tile, antislip glazed, white matte
With safety line in 307406 or 305136 (see page 58)
119 x 115 x 10 mm

562069 Grooved stair tile, antislip glazed, luminous blue
With safety line in anthracite or atlantic blue (antislip)
240 x 115 x 10 mm

562794 Corner, left, antislip glazed white matte or grey cream
With corner safety marking

562894 Corner, right, antislip glazed white matte or grey cream
With corner safety marking

	Price Group/ Piece	Price Group/ m ²	Price Group/ Piece	Price Group/ m ²	Price Group/ Piece	Price Group/ m ²
35136	● 235		● 238		● 268	
37406	● 236		● 238		● 268	
Pieces per m ² /r. m. incl. joints	8		4		538	
Approx. weight in KG/1000 pcs	250		538		538	
Pieces per bundle	60		30			
Pieces per pallet	3600					

● = Standard material ○ = Upon request □ = Pallet discount For colours please see p. 58

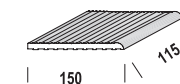
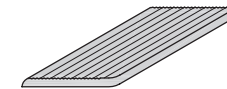
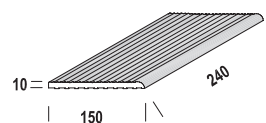
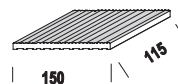
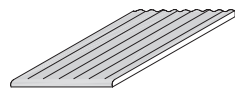
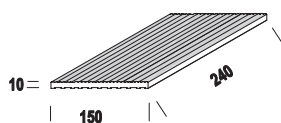

Colour	3190 Grooved tile 3191 Short side 240 x 150 x 10 mm		3195 Rounded on short side 240 x 150 x 10 mm		3290 ½ Grooved tile 115 x 150 x 10 mm 329044 ½ Grooved tile 119 x 150 x 10 mm		3196 Grooved tile, rounded on long side 240 x 150 x 10 mm 319644 Grooved tile, rounded on long side 244 x 150 x 10 mm		3197 Corner, left 3198 Corner, right 319744 Corner, left 319844 Corner, right		3296 ½ Grooved tile, rounded on long side 115 x 150 x 10 mm 329644 ½ Grooved tile, rounded on long side 119 x 150 x 10 mm	
	Price Group/ Piece	Price Group/ m ²	Price Group/ Piece	Price Group/ m ²	Price Group/ Piece	Price Group/ m ²	Price Group/ Piece	Price Group/ m ²	Price Group/ Piece	Price Group/ m ²	Price Group/ Piece	Price Group/ m ²
unglazed 1030	● 224		● 232		● 223			● 232		● 242		● 229
glazed 22106	● 232		● 234		● 230			● 235		● 247		● 233
Pieces per m ² /r. m. incl. joints	26				52		4		4		390	
Approx. weight in KG/1000 pcs	785		772		390		785		785		390	
Pieces per bundle	26				52		16		16		390	
Pieces per pallet	1248				1920		960		960		390	

● = Standard material ○ = Upon request □ = Pallet discount For colours please see p. 58

SPECIAL-FORM

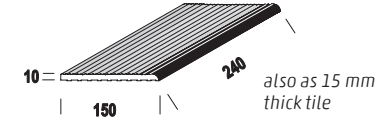
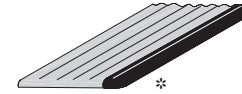
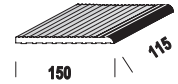
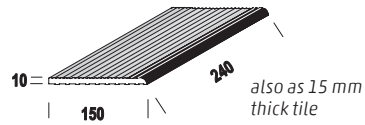

Colour glazed

	5630 Grooved stair tile, grey cream With safety line in anthracite or atlantic blue (antislip) 240 x 150 x 10 mm		5635 ½ Grooved stair tile, grey cream With safety line in anthracite or atlantic blue (antislip) 115 x 150 x 10 mm		5637 Corner, left* 5638 Corner, right 563744 Corner, left* 563844 Corner, right		563066 Grooved stair tile, antislip glazed, white matte With safety line in anthracite or atlantic blue (antislip) 240 x 150 x 10 mm	
	563044 Grooved stair tile, grey cream With safety line in 307406 or 305136 (see page 58) 244 x 150 x 10 mm		563544 ½ Grooved stair tile, grey cream With safety line in 307406 or 305136 (see page 58) 119 x 150 x 10 mm				563064 Grooved stair tile, antislip glazed, white matte With safety line in 307406 or 305136 (see page 58) 244 x 150 x 10 mm	
	Price Group/ Piece	Price Group/ m ²	Price Group/ Piece	Price Group/ m ²	Price Group/ Piece	Price Group/ m ²	Price Group/ Piece	Price Group/ m ²
35136	● 238		● 235		● 247		● 247	
37406	● 241		● 237		● 247		● 247	
Pieces per m ² /r. m. incl. joints	4		8				4	
Approx. weight in KG/1000 pcs	790		390		790		790	
Pieces per bundle	16		32		16		26	
Pieces per pallet	960		1920				960	

● = Standard material ○ = Upon request □ = Pallet discount For colours please see p. 58

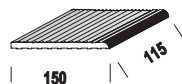

Colour glazed

563566 1/2 Grooved stair tile, antislip glazed, white matte
 With safety line in anthracite or atlantic blue (antislip)
 115 x 150 x 10 mm

563564 1/2 Grooved stair tile, antislip glazed, white matte
 With safety line in 307406 or 305136 (see page 58)
 119 x 150 x 10 mm

	Price Group/ Piece	Price Group/ m ²
35136	● 242	
37406	● 244	

Pieces per m ² /r. m. incl. joints	8
Approx. weight in KG/1000 pcs	390
Pieces per bundle	32
Pieces per pallet	1920

● = Standard material ○ = Upon request □ = Pallet discount
 For colours please see p. 58



Waerke Thyboron Vandkulturhus, Denmark

SPECIAL-FORM

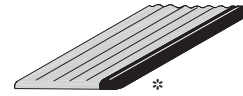
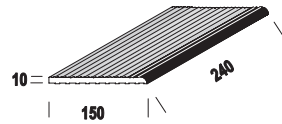

Colour
glazed

563069 Grooved stair tile, antislip glazed, luminous blue
With safety line in anthracite or atlantic blue (antislip)
240 x 150 x 10 mm

563766 Corner, left*
563866 Corner, right
563764 Corner, left*
563864 Corner, right

563794 Corner, left
563894 Corner, right

	Price Group/ Piece	Price Group/ m ²	Price Group/ Piece	Price Group/ m ²	Price Group/ Piece	Price Group/ m ²
35136	● 248		● 249		● 271	
37406	● 248		● 249		● 271	
<i>Pieces per m²/r. m. incl. joints</i>		4				
<i>Approx. weight in KG/1000 pcs</i>		790		790		790
<i>Pieces per bundle</i>		26		16		
<i>Pieces per pallet</i>		960				

● = Standard material ○ = Upon request □ = Pallet discount For colours please see p. 58

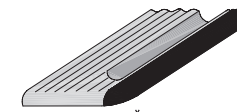
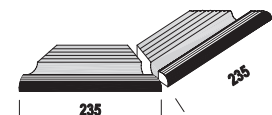
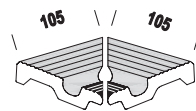
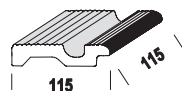
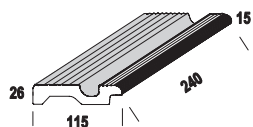

Colour glazed

	5730	5735	573203/04	573903/04	5737
	Grooved tile with hand grip, grey cream With safety line in anthracite or atlantic blue (antislip) 240 x 115 x 26/15 mm	½ Grooved tile with hand grip, grey cream With safety line in anthracite or atlantic blue (antislip) 115 x 115 x 26/15 mm	Internal corner 105 x 105 x 26/15 mm	External corner 235 x 115 x 26/15 mm	Corner, rounded left* Corner, rounded right
	573044 Grooved tile with hand grip, grey cream With safety line in 307406 or 305136 (see page 58) 244 x 115 x 26/15 mm	573544 ½ Grooved tile with hand grip, grey cream With safety line in anthracite or atlantic blue (antislip) 119 x 115 x 26/15 mm			573744 Corner, rounded left* 573844 Corner, rounded right
	Price Group/ Piece	Price Group/ m ²	Price Group/ Piece	Price Group/ m ²	Price Group/ Piece
35136	● 244		● 240	● 245 (Piece)	● 251 (Piece)
37406	● 245		● 242	● 245 (Piece)	● 251 (Piece)
Pieces per m ² /r. m. incl. joints	4	8			
Approx. weight in KG/1000 pcs	1073	530	300/300	780/780	1020
Pieces per bundle	14	28	1 pair	1 pair	
Pieces per pallet	840	1680			

● = Standard material ○ = Upon request □ = Pallet discount For colours please see p. 58

SPECIAL-FORM

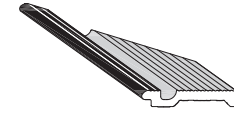
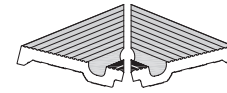
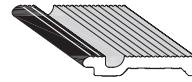
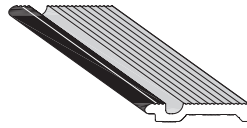

Colour glazed	5740 Grooved tile with hand grip, grey cream With safety line in anthracite or atlantic blue (antislip) 240 x 150 x 26/15 mm		5745 ½ Grooved tile with hand grip, grey cream With safety line in anthracite or atlantic blue (antislip) 115 x 150 x 26/15 mm		574203/ 04 Internal corner 150 x 150 x 26/15 mm		574903/ 04 External corner 238 x 150 x 26/15 mm	
	Price Group/ Piece	Price Group/ m ²	Price Group/ Piece	Price Group/ m ²	Price Group/ Piece	Price Group/ m ²	Price Group/ Piece	Price Group/ m ²
35136	● 250		● 249		● 254 (Piece)		● 268 (Piece)	
37406	● 250		● 249		● 254 (Piece)		● 268 (Piece)	
<i>Pieces per m²/r. m. incl. joints</i>	4		8				1115/1115	
<i>Approx. weight in KG/1000 pcs</i>	1426		700		390/390		1115/1115	
<i>Pieces per bundle</i>	12		24		1 pair		1 pair	
<i>Pieces per pallet</i>								

● = Standard material ○ = Upon request □ = Pallet discount For colours please see p. 58

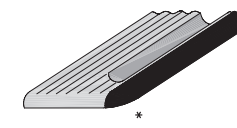
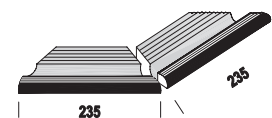
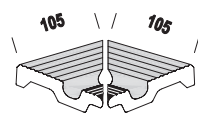
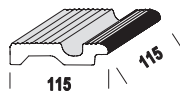
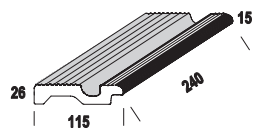

Colour glazed

573073 Grooved tile with hand grip, antislip glazed, white matte
With safety line in anthracite or atlantic blue (antislip)
240 x 115 x 26/15 mm

573074 Grooved tile with hand grip, antislip glazed, white matte
With safety line in 307406 or 305136 (see page 58)
244 x 115 x 26/15 mm

573573 ½ Grooved tile with hand grip, antislip glazed, white matte
With safety line in anthracite or atlantic blue (antislip)
115 x 115 x 26/15 mm

573574 ½ Grooved tile with hand grip, antislip glazed, white matte
With safety line in 307406 or 305136 (see page 58)
119 x 115 x 26/15 mm

573265/66 Internal corner
105 x 105 x 26/15 mm

573965/66 External corner
235 x 115 x 26/15 mm

573773 Corner, rounded left*
573873 Corner, rounded right
573774 Corner, rounded left*
573874 Corner, rounded right
Upon request corner safety marking is available

	Price Group/ Piece	Price Group/ m ²	Price Group/ Piece	Price Group/ m ²	Price Group/ Piece	Price Group/ m ²	Price Group/ Piece	Price Group/ m ²	Price Group/ Piece	Price Group/ m ²
35136	● 248		● 245		● 248 (Piece)		● 257 (Piece)		● 275	
37406	● 248		● 245		● 248 (Piece)		● 257 (Piece)		● 275	
Pieces per m ² /r. m. incl. joints		4		8						
Approx. weight in KG/1000 pcs		1073		530		300/300		780/780		1020
Pieces per bundle		14		28		1 pair		1 pair		
Pieces per pallet		840		1680						

● = Standard material ○ = Upon request □ = Pallet discount For colours please see p. 58

SPECIAL-FORM

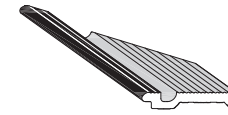
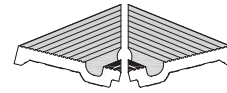
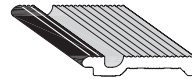
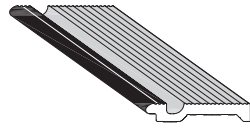

Colour glazed

	574073 Grooved tile with hand grip, antislip glazed, white matte With safety line in anthracite or atlantic blue (antislip) 240 x 150 x 26/15 mm		574573 ½ Grooved tile with hand grip, antislip glazed, white matte With safety line in anthracite or atlantic blue (antislip) 115 x 150 x 26/15 mm		574265/66 Internal corner 150 x 150 x 26/15 mm		574965/66 External corner 238 x 150 x 26/15 mm		5720 Grooved tile with hand grip 240 x 65 x 26/15 mm 572044 Grooved tile with hand grip 244 x 65 x 26/15 mm	
	Price Group/ Piece	Price Group/ m ²	Price Group/ Piece	Price Group/ m ²	Price Group/ Piece	Price Group/ m ²	Price Group/ Piece	Price Group/ m ²	Price Group/ Piece	Price Group/ m ²
35136	● 252		● 250		● 261 (Piece)		● 272 (Piece)		● 249	
37406	● 252		● 250		● 261 (Piece)		● 272 (Piece)		● 249	
Pieces per m ² /r. m. incl. joints	4		8				1115/1115		4	
Approx. weight in KG/1000 pcs	1476		700		390/390		1115/1115		620	
Pieces per bundle	12		24		1 pair		1 pair		14	
Pieces per pallet										

● = Standard material ○ = Upon request □ = Pallet discount For colours please see p. 58

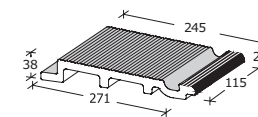
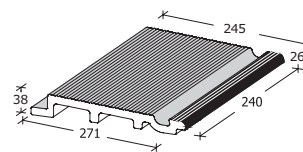
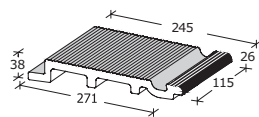
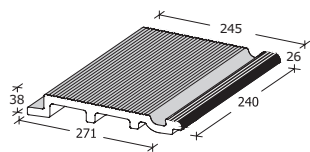

Colour glazed

9727 Handrail tile with grating rest (large), antislip glazed, white matte
 With safety line in anthracite or atlantic blue (antislip)
 240 x 271/245 x 38/14 mm

972744 Handrail tile with grating rest (large), antislip glazed, white matte
 With safety line in anthracite or atlantic blue (antislip)
 244 x 271/245 x 38/14 mm

972760 1/2 Handrail tile with grating rest (large), antislip glazed, white matte
 With safety line in anthracite or atlantic blue (antislip)
 115 x 271/245 x 38/14 mm

972764 1/2 Handrail tile with grating rest (large), antislip glazed, white matte
 With safety line in anthracite or atlantic blue (antislip)
 119 x 271/245 x 38/14 mm

972700 Handrail tile with grating rest (large), antislip glazed, grey cream
 With safety line in anthracite or atlantic blue (antislip)
 240 x 271/245 x 38/14 mm

972745 Handrail tile with grating rest (large), antislip glazed, grey cream
 With safety line in anthracite or atlantic blue (antislip)
 244 x 271/245 x 38/14 mm

972761 1/2 Handrail tile with grating rest (large), antislip glazed, grey cream
 With safety line in anthracite or atlantic blue (antislip)
 115 x 271/245 x 38/14 mm

972765 1/2 Handrail tile with grating rest (large), antislip glazed, grey cream
 With safety line in anthracite or atlantic blue (antislip)
 119 x 271/245 x 38/14 mm

	Price Group/ Piece	Price Group/ m ²	Price Group/ Piece	Price Group/ m ²	Price Group/ Piece	Price Group/ m ²	Price Group/ Piece	Price Group/ m ²
35136	● 264		● 260		● 264		● 260	
37406	● 264		● 260		● 264		● 260	
Pieces per m ² /r.m. incl. joints		4		8		4		8
Approx. weight in KG/1000 pcs		2620		1300		2620		1300
Pieces per bundle								
Pieces per pallet								

● = Standard material ○ = Upon request □ = Pallet discount For colours please see p. 58

„Finnish channel" with grating rest

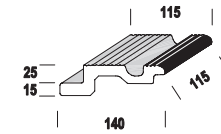
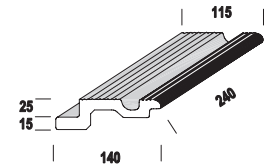
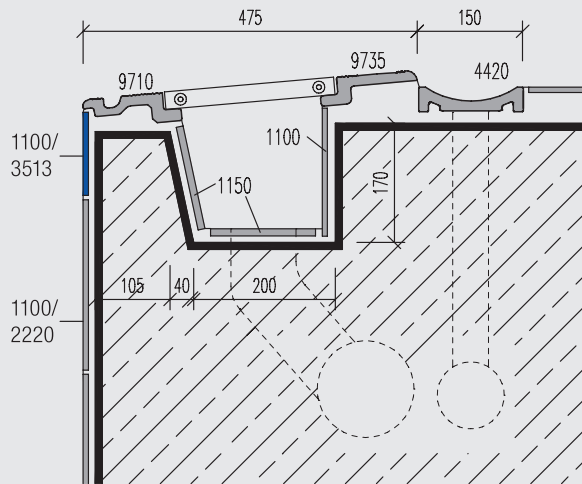

Colour
glazed

- 9710 Handrail tile with grating rest, antislip glazed, white matte**
With safety line in anthracite or atlantic blue (antislip)
240 x 140/115 x 40/15 mm
- 971044 Handrail tile with grating rest, antislip glazed, white matte**
With safety line in anthracite or atlantic blue (antislip)
244 x 140/115 x 40/15 mm

- 971060 ½ Handrail tile with grating rest, antislip glazed, white matte**
With safety line in anthracite or atlantic blue (antislip)
115 x 140/115 x 40/15 mm
- 971064 ½ Handrail tile with grating rest, antislip glazed, white matte**
With safety line in anthracite or atlantic blue (antislip)
119 x 140/115 x 40/15 mm

	Price Group/ Piece	Price Group/ m ²	Price Group/ Piece	Price Group/ m ²
35136	● 256		● 253	
37406	● 257		● 254	
Pieces per m ² /r. m. incl. joints		4		8
Approx. weight in KG/1000 pcs		1600		775
Pieces per bundle		8		16
Pieces per pallet		480		960

● = Standard material ○ = Upon request □ = Pallet discount For colours please see p. 58

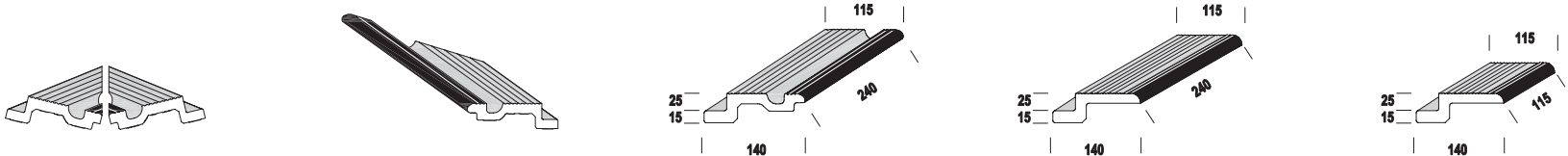

Colour
glazed

	971203/ 04 Internal corner 133 x 133 x 40/15 mm		971903/ 04 External corner 238 x 140/115 x 40/15 mm		971043 Handrail tile with grating rest, antislip, grey cream With safety line in anthracite or atlantic blue (antislip) 240 x 140/115 x 40/15 mm		971045 Handrail tile with grating rest, antislip, grey cream With safety line in anthracite or atlantic blue (antislip) 244 x 140/115 x 40/15 mm		9735 Grooved tile, with grating rest, antislip glazed, white matte With safety line in anthracite or atlantic blue (antislip) 240 x 140/115 x 40/15 mm		973544 Grooved tile, with grating rest, antislip glazed, white matte With safety line in anthracite or atlantic blue (antislip) 244 x 140/115 x 40/15 mm		973560 ½ Grooved tile, with grating rest, antislip glazed, white matte With safety line in anthracite or atlantic blue (antislip) 115 x 140/115 x 40/15 mm		973564 ½ Grooved tile, with grating rest, antislip glazed, white matte With safety line in anthracite or atlantic blue (antislip) 119 x 140/115 x 40/15 mm	
	Price Group/ Piece	Price Group/ m ²	Price Group/ Piece	Price Group/ m ²	Price Group/ Piece	Price Group/ m ²	Price Group/ Piece	Price Group/ m ²	Price Group/ Piece	Price Group/ m ²	Price Group/ Piece	Price Group/ m ²	Price Group/ Piece	Price Group/ m ²	Price Group/ Piece	Price Group/ m ²
35136	● 257 (Piece)		● 269 (Piece)		● 253		● 256		● 256		● 253		● 253			
37406	● 257 (Piece)		● 269 (Piece)		● 256		● 257		● 257		● 254					
Pieces per m ² /r. m. incl. joints							4		4		8		8			
Approx. weight in KG/1000 pcs		560		2000		1600		1600		1600		800		800		
Pieces per bundle		1 pair		1 pair		8		8		8		16		16		
Pieces per pallet						480		360		360		720		720		

● = Standard material ○ = Upon request □ = Pallet discount For colours please see p. 58

SPECIAL-FORM

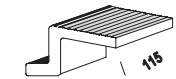
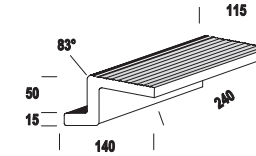
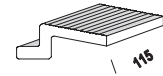
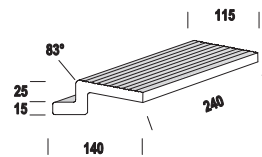
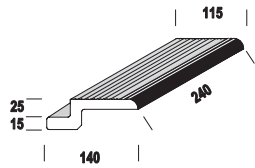

Colour

973500 Grooved tile, with grating rest, antislip, grey cream
With safety line in anthracite or atlantic blue (antislip)
240 x 140/115 x 40/15 mm

973545 Grooved tile, with grating rest, antislip, grey cream
With safety line in anthracite or atlantic blue (antislip)
244 x 140/115 x 40/15 mm

9775 Grooved tile, with grating rest, angled, antislip
240 x 140/115 x 40/15 mm

977544 Grooved tile, with grating rest, angled, antislip
244 x 140/115 x 40/15 mm

977560 ½ Grooved tile, with grating rest, angled, antislip
115 x 140/115 x 40/15 mm

977564 ½ Grooved tile, with grating rest, angled, antislip
119 x 140/115 x 40/15 mm

9700 Grooved tile with grating rest, grey cream
With safety line in anthracite or atlantic blue (antislip)
240 x 140/115 x 65/15 mm

970044 Grooved tile with grating rest, grey cream
With safety line in anthracite or atlantic blue (antislip)
244 x 140/115 x 65/15 mm

9705 ½ Grooved tile with grating rest, grey cream
With safety line in anthracite or atlantic blue (antislip)
115 x 140/115 x 65/15 mm

970544 ½ Grooved tile with grating rest, grey cream
With safety line in anthracite or atlantic blue (antislip)
119 x 140/115 x 65/15 mm

		Price Group/ Piece	Price Group/ m ²	Price Group/ Piece	Price Group/ m ²	Price Group/ Piece	Price Group/ m ²	Price Group/ Piece	Price Group/ m ²
unglazed	1030			● 247		● 245			
glazed	22106			● 248		● 247			
	35136	● 253					● 256	● 253	
	37406	● 256					● 257	● 254	
Pieces per m ² /r. m. incl. joints		4		4		8		4	
Approx. weight in KG/1000 pcs		1600		1384		663		1320	
Pieces per bundle		8		9		18		8	
Pieces per pallet		360		360		720		360	

● = Standard material ○ = Upon request □ = Pallet discount For colours please see p. 58

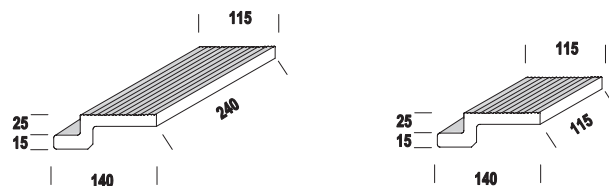

Colour

9795	Grooved tile, with grating rest 240 x 140/115 x 40/15 mm	979560	½ Grooved tile, with grating rest 115 x 140/115 x 40/15 mm
979544	Grooved tile, with grating rest 244 x 140/115 x 40/15 mm	979564	½ Grooved tile, with grating rest 119 x 140/115 x 40/15 mm

		Price Group/ Piece	Price Group/ m ²	Price Group/ Piece	Price Group/ m ²
unglazed	1030	● 247		● 245	
glazed	22106	● 248		● 247	
Pieces per m ² /r.m. incl. joints			4		8
Approx. weight in KG/1000 pcs			1448		694
Pieces per bundle			9		18
Pieces per pallet			648		1296

● = Standard material ○ = Upon request □ = Pallet discount For colours please see p. 58



Parkbad Hamburg Volksdorf, Hamburg, Germany (bs2architekten)

SPECIAL-FORM

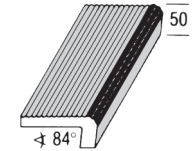
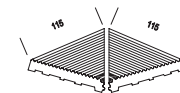
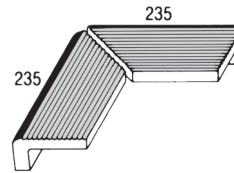
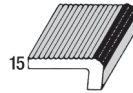
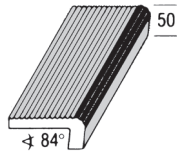

Colour glazed

	5700 Grooved angle tile with hand grip, grey cream With safety line in anthracite or atlantic blue (antislip) 240/50 x 115 x 15 mm		5705 ½ Grooved angle tile with hand grip, grey cream With safety line in anthracite or atlantic blue (antislip) 115/50 x 115 x 15 mm		570203/04 External corner with hand grip, grey cream 235/50 x 115 x 15 mm		570903/04 Internal corner with hand grip, grey cream 115 x 115 x 15 mm		570062 Grooved angle tile with hand grip, antislip glazed, white matte With safety line in anthracite or atlantic blue (antislip) 240/50 x 115 x 15 mm	
	570044 Grooved angle tile with hand grip, grey cream With safety line in anthracite or atlantic blue (antislip) 244/50 x 115 x 15 mm		570544 ½ Grooved angle tile with hand grip, grey cream With safety line in anthracite or atlantic blue (antislip) 119/50 x 115 x 15 mm						570064 Grooved angle tile with hand grip, antislip glazed, white matte With safety line in anthracite or atlantic blue (antislip) 244/50 x 115 x 15 mm	
	Price Group/ Piece	Price Group/ m ²	Price Group/ Piece	Price Group/ m ²	Price Group/ Piece	Price Group/ m ²	Price Group/ Piece	Price Group/ m ²	Price Group/ Piece	Price Group/ m ²
35136	● 248		● 247		● 248 (Piece)		● 248 (Piece)		● 252	
37406	● 249		● 248		● 249 (Piece)		● 249 (Piece)		● 253	
Pieces per m ² /r. m. incl. joints	4		8		890/890		260/260		4	
Approx. weight in KG/1000 pcs	900		563		890/890		260/260		900	
Pieces per bundle	9		18						9	
Pieces per pallet	540		1080						540	

● = Standard material ○ = Upon request □ = Pallet discount For colours please see p. 58

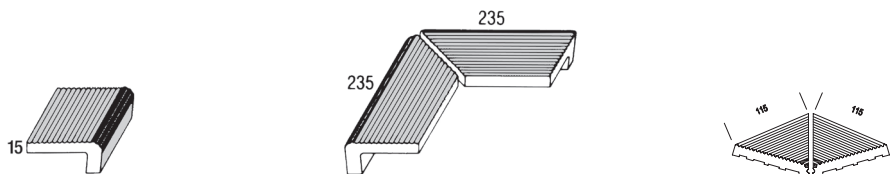

Colour glazed

	570562 ½ Grooved angle tile with hand grip, antislip glazed, white matte With safety line in anthracite or atlantic blue (antislip) 115/50 x 115 x 15 mm		570267/ 68 External corner 235/50 x 115 x 15 mm		570967/ 68 Internal corner 115 x 115 x 15 mm	
	Price Group/ Piece	Price Group/ m ²	Price Group/ Piece	Price Group/ m ²	Price Group/ Piece	Price Group/ m ²
35136	● 249		● 252 (Piece)		● 252 (Piece)	
37406	● 251		● 253 (Piece)		● 253 (Piece)	
Pieces per m ² /r. m. incl. joints	8				260/260	
Approx. weight in KG/1000 pcs	563		890/890		260/260	
Pieces per bundle	18		1 pair		1 pair	
Pieces per pallet	1080					

● = Standard material ○ = Upon request □ = Pallet discount For colours please see p. 58



Natuurpoort Nederheide, Milheeze, Netherlands

SPECIAL-FORM

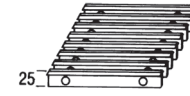
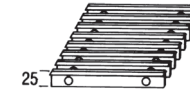
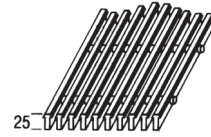
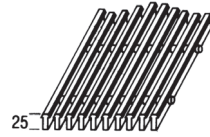

Colour	0935 Rigid cover grid, light grey* 0816 Rigid cover grid, white*		0937 Rigid cover grid, light grey* 0807 Rigid cover grid, white*		0931 Flexible cover grid, light grey* 0839 Flexible cover grid, white*		0933 Flexible cover grid, light grey* 0826 Flexible cover grid, white*	
	18 cm wide (standard length 200 cm) Rigid PVC acc. to DIN 16929		24 cm wide (standard length 200 cm) Rigid PVC acc. to DIN 16929		18 cm wide (standard length 200 cm) Rigid PVC acc. to DIN 16929		24 cm wide (standard length 200 cm) Rigid PVC acc. to DIN 16929	
	Price Group/ Piece	Price Group/ Linear meter Net prices - no discount applicable	Price Group/ Piece	Price Group/ Linear meter Net prices - no discount applicable	Price Group/ Piece	Price Group/ Linear meter Net prices - no discount applicable	Price Group/ Piece	Price Group/ Linear meter Net prices - no discount applicable
Light grey*		282**		283**		281**		282**
White*		282**		283**		281**		282**
<i>Approx. weight kgs per sqm / lm</i>		2,8	3,7	2,9	3,9			

● = Standard material ○ = Upon request □ = Pallet discount

* More colours upon request: yellow, beige, blue, black, red and pale ivory

** Please note conditions: Nettopreise - Net prices - no discount applicable

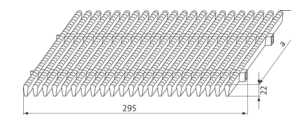
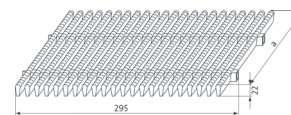
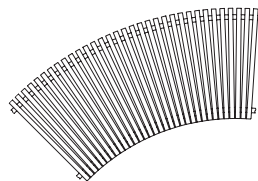
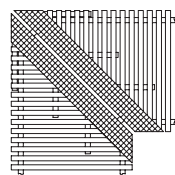

Colour	093401 Corner piece		093301 Curved flexible cover grid		0936 Plug-in grid, light grey 0817 Plug-in grid, white 18 cm wide		0938 Plug-in grid, light grey 0808 Plug-in grid, white 24 cm wide	
	Price Group/ Piece	Preisgruppe/ lft.m	Price Group/ Piece	Preisgruppe/ lft.m	Price Group/ Piece	Price Group/ Linear meter Net prices - no discount applicable	Price Group/ Piece	Price Group/ Linear meter Net prices - no discount applicable
Light grey*	Price upon request		Price upon request			273**		279**
White*	Price upon request		Price upon request			273**		279**
Approx. weight kgs per sqm / lm						1,4		1,9

● = Standard material ○ = Upon request □ = Pallet discount ** Please note conditions: Nettopreise - Net prices - no discount applicable

Useful information

Cover grid widths up to 350 mm are available on request.
 Custom-made curved pieces of flexible cover grid can be manufactured upon request with exact dimensions and/or stencils are made available from job site.
 All rigid and flexible cover grids are also available in 22 mm thickness and other colours, please ask for more details.

SPECIAL-FORM

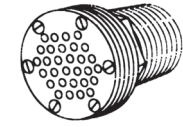
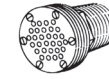
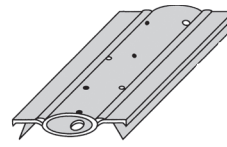
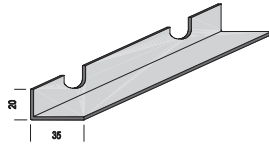
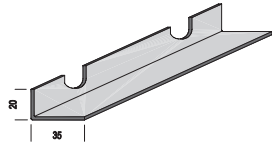

0957 Corner support for 0931 and 0839		0958 Corner support for 0933 and 0826		0768 Vertical continuous flow system for pool floors (Hoelscher System)		0960 Sieve valve 1½" metal, suitable for: 5111, 4429		0961 Sieve valve 2½" metal, suitable for: 5101, 5161, 5171	
Price Group/ Piece	Price Group/ m ²	Price Group/ Piece	Price Group/ m ²	Price Group/ Piece	Price Group/ m ²	Price Group/ Piece	Price Group/ m ²	Price Group/ Piece	Price Group/ m ²
257*		257*		Preis auf Anfrage		278*		282*	
<i>Pieces per m²/r. m. incl. joints</i>						350		1150	
<i>Approx. weight in KG/1000 pcs</i>									
<i>Pieces per bundle</i>									
<i>Pieces per pallet</i>									

● = Standard material ○ = Upon request □ = Pallet discount ** Please note conditions: Nettopreise - Net prices - no discount applicable

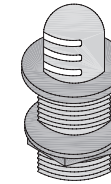
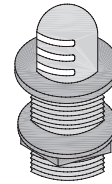
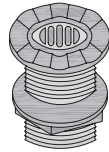

0965 Sieve valve 2 1/2" plastic, suitable for: 5101, 5161, 5171		0966 Silent sieve valve 1 1/2" plastic, suitable for: 5111, 4429		0964 Silent sieve valve 2 1/2" plastic, suitable for: 5101, 5161, 5171	
Price Group/ Piece	Price Group/ m ²	Price Group/ Piece	Price Group/ m ²	Price Group/ Piece	Price Group/ m ²
272*		272*		278*	
<i>Pieces per m²/r. m. incl. joints</i>					
175		350		350	
<i>Approx. weight in KG/1000 pcs</i>					
<i>Pieces per bundle</i>					
<i>Pieces per pallet</i>					

● = Standard material ○ = Upon request □ = Pallet discount ** Please note conditions: Nettopreise - Net prices - no discount applicable

■ Design and tiling plans

GAIL supports planners and architects with design proposals and detailed laying plans. Many prestigious buildings worldwide have been realised in collaboration with our planning department.

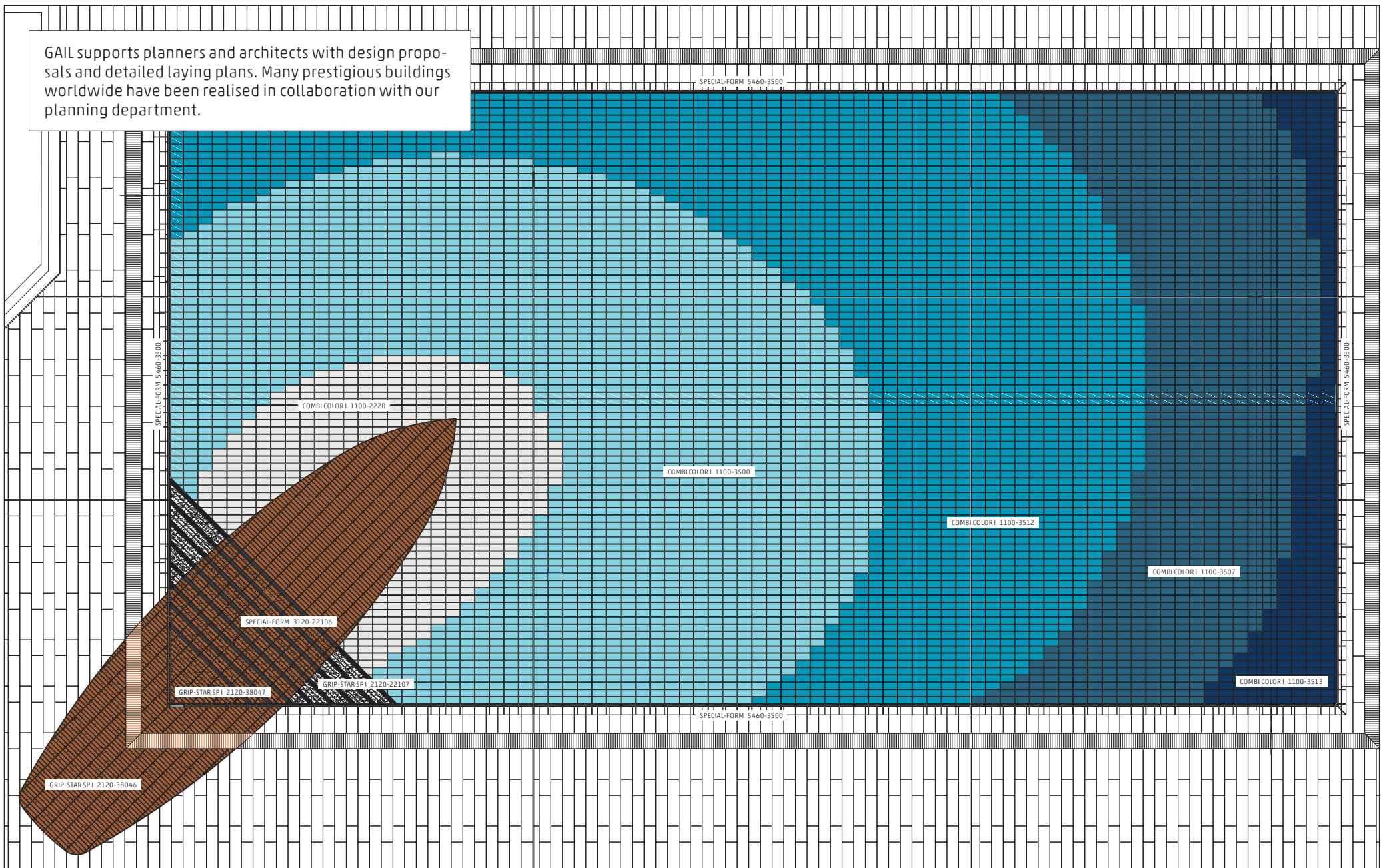

All information on dimensions, weights, packaging, colours, price groups etc. is given in good faith and to the best of our knowledge. We reserve the right to make any changes that may become necessary after the catalogue has been printed, for whatever reason, and without prior notice. We accept no liability for this and our liability derived from this is completely excluded. The written details in our respective order confirmations always apply.

Index according to size numbers

Size no.	Page no.	Size no.	Page no.	Size no.	Page no.	Size no.	Page no.	Size no.	Page no.	Size no.	Page no.
0101	49	110544	45, 87	202863	53	3236	91	4723	8	511564	64
0202	49	1106	29, 41, 87	202864	53	323644	91	4724	8	511565	64
0748	83	110644	45, 87	2120	7, 28, 41	3290	95	4811	30	511703	65
0768	112	1107	29, 41, 87	2121	28	329044	95	4822	8, 13, 30	511704	65
0807	110	110744	45, 87	2122	28	3296	95	482231	17	5160	70
0808	111	1108	29, 41, 87	2123	28	329644	95	482245	17	516044	70
0816	110	110844	45, 87	2124	28	4000	8, 30, 82	4875	8	5161	70
0817	111	1110	10	2521	8	400044	37, 46, 82	4885	89	516144	70
0826	110	111042	42	2525	17	4001	9, 30, 82	488544	89	516203	71
0839	110	1114	10	3030	56	400144	37	488562	89	516204	71
0931	110	1115	10	303047	24	4002	9, 30, 82	488564	89	5163	71
0933	110	1116	10	3060	24	400244	37	4888	14	5164	71
093401	111	1117	10	3120	91	400503	9, 30, 37, 82	4900	84	5165	70
093301	111	1118	10	312044	91	400504	9, 30, 37, 82	490044	84	516544	70
0935	110	1120	10	3130	90	400543	82	4901	84	516560	70
0936	111	1150	29, 87	313044	90	400544	82	490144	84	516561	70
0937	110	115044	87	3131	90	4030	8	490303	84	516564	71
0938	111	1151	29, 87	313144	90	4031	9	490304	84	516565	71
0957	112	115144	87	3135	90	4032	9	4905	84	5170	66
0958	112	1152	29, 87	313544	90	403503	9	490544	84	517044	66
0960	112	115244	87	3136	91	403504	9	5100	62	5171	66
0961	112	1153	29, 87	313644	91	4100	9, 31, 81	510044	62	517144	66
0964	113	115344	87	3137	91	410044	37, 81	5101	62	517203	67
0965	113	1154	29, 87	313744	91	4101	9, 31, 81	510144	62	517204	67
0966	113	115444	87	3138	91	410144	37, 81	510203	63	5173	67
1030	56	1155	87	313844	91	4102	10, 31, 81	510204	63	5174	67
1100	7, 13, 28, 41	115544	87	3170	90	4200	81	5103	63	5175	66
110042	42	1156	87	317044	90	420044	81	5104	63	517544	66
11004T	36, 45	115644	87	3190	95	4203	9, 31, 81	5105	62	517503	66
1101	28, 41	1157	87	319044	95	4204	9, 31, 81	510544	62	517504	66
110142	42	115744	87	3191	95	4420	83	5110	64	5180	74
11014T	36, 45	1158	87	319144	95	442044	83	511044	64	518044	74
1102	28, 41	115844	87	3195	95	442303	83	5111	64	518203	74
110242	42	1200	7, 29, 41	319544	95	442304	83	511144	64	518204	74
11024T	36, 45	120042	42	3196	95	4424	83	511203	64	5185	74
1103	28, 41	120044	36, 45	319644	95	4429	83	511204	64	518544	74
110342	42	1201	29, 41	3197	95	442944	83	5113	65	518903	74
11034T	36, 45	1203	29, 41	319744	95	4509	85	5114	65	518904	74
1104	28, 41	1610	7, 13	3198	95	450944	85	5115	64	5260	72
110442	42	161044	36, 45	319844	95	4600	7, 14	511544	64	526044	72
11044T	36, 45	2020	53, 56	3230	90	4720	45	511560	64	5261	72
1105	29, 41, 87	202860	53	323044	90	472003	45	511561	64	526144	72

Size no.	Page no.	Size no.	Page no.	Size no.	Page no.	Size no.	Page no.	Size no.	Page no.	Size no.	Page no.
5265	72	5460	77	563744	96	573774	101	903964	89	9710	104
526544	72	546044	77	563764	98	5738	99	9068	7	971043	105
526560	72	546201	77	563766	98	573844	99	9087	14	971044	104
526561	72	546202	77	563794	98	573873	101	908703	14	971045	105
526203	73	546303	77	5638	96	573874	101	9089	7	971060	104
526204	73	546304	77	563844	96	573903	99	908903	8	971064	104
5263	73	5465	77	563864	98	573904	99	915408	85	971203	105
526344	73	546544	77	563866	98	573965	101	915410	85	971204	105
5264	73	5563	86	563894	98	573966	101	9412	79	971903	105
526444	73	556344	86	5700	108	5740	100	941244	79	971904	105
526564	73	5565	86	570044	108	574044	100	941257	79	9727	103
526565	73	5620	92	570062	108	574073	102	941258	79	972700	103
5270	68	562015	92	570064	108	574074	102	941264	79	972744	103
527044	68	562044	92	570203	108	574203	100	941269	79	972745	103
5271	68	562045	92	570204	108	574204	100	9415	79	972760	103
527144	68	562060	93	570267	109	574265	102	941544	79	972761	103
527203	69	562064	93	570268	109	574266	102	9450	80	972764	103
527204	69	562069	94	5705	108	5745	100	945044	38, 46, 80	972765	103
5275	68	5625	93	570544	108	574544	100	945061	38, 46, 80	9735	105
527503	68	562544	93	570562	109	574573	102	945064	38, 46, 80	973500	106
527504	68	562560	94	570564	109	574574	102	945067	38, 46, 80	973544	105
527544	68	562564	94	570903	108	574903	100	945068	38, 46, 80	973560	105
5273	69	5627	92	570904	108	574904	100	9455	80	973564	105
5274	69	562744	92	570967	109	574965	102	945544	46, 80	973545	106
527603	69	562760	93	570968	109	574966	102	956701	71	9775	106
527604	69	562764	93	5720	102	5750	78	956702	71	977544	106
5400	75	562794	94	572044	102	575044	78	956703	71	977560	106
540044	75	5628	92	5730	99	5755	78	956704	71	977564	106
540201	75	562844	92	573044	99	575544	78	956903	63	9795	107
540202	75	562860	93	573073	101	606020	20, 22	956904	63	979544	107
540303	75	562864	93	573074	101	8830	17	957603	67	979560	107
540304	75	562894	94	573203	99	8835	18	957604	67	979564	107
5405	75	5630	96	573204	99	883508	18	9577	62		
540544	75	563044	96	573265	101	8838	18	957744	62		
5450	76	563064	96	573266	101	883827	18	9578	62		
545044	76	563066	96	5735	99	883828	18	957844	62		
545201	76	563069	98	573544	99	8840	18	96097	85		
545202	76	5635	96	573573	101	9039	89	960974	85		
545303	76	563544	96	573574	101	903944	89	9700	106		
545304	76	563564	97	5737	99	903962	89	970044	106		
5455	76	563566	97	573744	99	903964	89	9705	106		
545544	76	5637	96	573773	101	903962	89	970544	106		

■ Index according to colour numbers

Colour no.	Page no.
1000	6
1001	44
100142	44
1030	6, 40, 58
1030F	6
100307	6
1031	44
103142	44
1125	6
1180	12
1300	6
1395	12
1701	44
170142	44
1705	6
1710	6
1731	44
173142	44
20114	34
20115	34
2020	34
202106	44
202107	44
2090	34
2113	26
2114	26
2115	26, 58
2180	26
22106	40, 58
22107	40
2220	26, 58
2290	26, 58
22908	48
229086	48
22936	40
2902	26

Colour no.	Page no.
30102	34
30110	34
30112	34
30113	34
30117	34
30119	34
30314	34
30315	34
30400	34
30404	34
304046	44
304047	44
30500	35
30501	34
30502	35
30505	35
30507	34
30510	34
30511	34
30513	35
305136	44
305137	44
30514	34
30518	35
305186	44
30519	34
30521	35
30536	35
305366	44
30540	35
305956	44
305957	44
30619	35
30622	35
306226	44
30627	35

Colour no.	Page no.
30701	34
30731	34
30735	34
307356	44
30738	34
30740	34
30804	34
30805	34
30806	34
30807	34
30814	34
30815	34
30823	34
3100	26
3102	26
3111	26
3112	26
3117	26
3119	26
3304	26
3315	26
3400	26
3401	26
3402	26
3407	27
3500	27, 58
35008	48
350086	48
3501	27
3505	27, 58
3507	27
3512	27, 58
35126	40
3513	27, 58
35136	40, 58
35137	40

Colour no.	Page no.
35138	48
3514	27
3518	27, 58
35186	40
35188	48
3519	27
3521	27, 58
35216	40
35218	48
35956	40, 58
35957	40
3605	27
3613	27
3619	27
36198	48
3621	27
3627	27, 58
36276	40
36278	48
3701	26
3730	26
3731	26
3735	26
3738	26
3739	26
3740	26, 58
37406	40, 58
37407	40
3801	26
3804	26
3815	26
3823	26
3825	26
46256	16
46257	16
46357	16

Colour no.	Page no.
46456	16
46556	16
46557	16
46856	16
46857	16
46956	16
46957	16
4820	12
4880	12
50104	34
50131	35
501316	44
50132	35
501326	44
50303	35
503036	44
50310	35
50515	35
505156	44
50522	35
50622	35
5104	26
5131	26
51315	40
51316	40
5303	26, 52
53035	40
53036	40
5310	26
5321	26
5405	27
5515	27
5522	27
5623	27
5636	27
6150	24

Colour no.	Page no.
6155	24
6160	24
6165	24
6170	24
8292	20
8295	20
8296	20
8393	22
8394	22
8396	22
8719	52
8720	52, 56
8722	52
8724	52
8727	52
8728	52
8732	52
8734	52
8736	52
8741	52
8743	52
8746	52
8748	52, 56
8749	52
8751	52
8752	52
8753	52
8754	56
8756	56
99999	48

Gail

Gail Ceramics International GmbH

Gambacher Weg 5

D-35415 Pohlheim

Tel.: +49 6004 49999-10

Fax: +49 6004 49999-16

Email: sales@gail.de

www.gail.de